

Narrow Beam Spotlights Outdoor



**Outdoor Spot Light MX-500
Energy Saving 11W**



R11 projector with fluorescent lamp 11 watt - as bright as 50W incandescent light.

LA-1037

Only 3 pieces available.

Floodlight with built-in, low-loss ballast.

High-quality housing of Italian manufacture.

Focused light distribution for illuminating advertising signs or smaller objects.

Energy-saving, with built-in low-loss ballast for low power consumption.

Complete with compact fluorescent lamp 11W GU10 (15.000 hrs.)

Luminous intensity 600 Lm

Light circle diameter 1m / 2m with distance 1m / 2m

Cast aluminium housing black or white.

Protection class IP55

Dimensions: D 140mm, W 185mm, H 235mm.

Ideal for entrance areas, garden and plant lighting, advertising signs and wherever directional light of not too great intensity is required.

Due to the enormous lamp life and the low power consumption, this spotlight is suitable for long-term operation.

We recommend combining it with a twilight switch or a timer so that the luminaire switches off automatically during the day.

Weight: 1,2 kg

LED Floodlights and Spotlights Outdoor max. 50W



**Outdoor Floodlight Energy
Saving 2* 26W**



Adjustable luminary fixture for energy economizing fluorescent lamps. 2 x 26 watt - as bright as 250w incandescent lamp. Black
LA-1039

Energy-saving flood light with integrated ballast for low energy drain.

For 2x fluorescent lamp PL-C G24d-3 with 26W (10.000h).

Please order the lamps extra.

Solid aluminium die-cast case. Grey or black.

Protection-class IP 55 / 850°C.

Measurements: L 160mm, w 235mm, h 110mm.

Only few items on stock

Weight: 5 kg

Sign Board Lighting



Outdoor Wall Flood Light Arm Triangolo Halogen



Decorative billboard lighting halogen 150 - 300W made of solid aluminium for shop entrances and other lighting.
 Manufacturer Goccia Italy
 Stock: 2 pieces
 LA-1043H

Very high quality housing with cooling fins.
 Can be fitted with halogen lamp R7s 118mm max. 300W or energy-saving lamp 23W.
 With adjustable tilt angle.

Dimensions:
 Width 210mm,
 height 198mm,
 depth 120mm.
 Material: aluminium, silver anodised
 Weight: 2,35 kg



Signboard Light Day MH-70W Long-Arm



Energy-saving, slender outdoor spotlight with wall arm for billboard, advertising board. HQI lamp, as bright as 300W halogen.
 Remaining stock
 LA-1044-07

Long wall bracket 1 metre.
 Swivelling spotlight made of die-cast aluminium.
 With ballast unit suitable for lamp HQI-TS 70W Rx7s.
 This lamp type is very long-lasting, low-maintenance, bright and yet energy-saving.
 (Please order lamp separately)
 The outdoor flood arm Day has a safety glass and a bracket for wall mounting.
 Very bright, ideal for facades of shops, restaurants or for advertising boards.
 Beam angle: Width 80°, height asymmetrical 40°.
 Mounting must be downward-facing only, IP33
 Wall bracket: painted steel
 Length of wall bracket 100cm
 Lamp housing: white lacquered aluminium
 Lamp head: Width 173mm, H 87mm, L 210mm
 Colour: white
 Weight: 5,35 kg



LED Sign-Board Light 30W with Long Arm



Very bright LED projector for illuminating billboards or advertising signs.
 Energy-saving.
 LA-1054-1

Durable Power LEDs and floodlights with adjustable tilt angle.
 The light intensity equivalent to 300 watt halogen light.
 Includes long-lasting power LED lamp.

Light distribution: 120° very wide and equal.
 Light color: 4000 K nature white
 Supply voltage: 230V 50Hz
 Power consumption: 32 W
 Material: die-cast aluminum, grey powder-coated.
 Protection degree: IP65
 Arm length: 100cm
 Weight: 3,55 kg



LED Sign-Board Light 50W with Long Arm



Very bright LED projector for illuminating billboards or advertising signs. Energy-saving.
LA-1054-2

Robust LED floodlight with adjustable tilt angle. The light intensity corresponds to about 500 watts of halogen light. Includes long-life Power LED lamp 50000 hrs.

Light emission: 120° very wide and uniformly bright
Luminous flux: 4700 Lm - comparable to a 150W metal halide high-pressure lamp.
Light colour: 4000 K neutral white
Supply voltage: 230V 50Hz
Power consumption: 51 Watt
Material: die-cast aluminium, grey powder-coated. (White on request)
Protection class: IP65
Arm length: 100cm
Dimensions of the spotlight: width 220, height 220, depth 145 mm.
Weight: 3,55 kg



LED Double Billboard Light with Long Arm



Two LED Luminaries for outdoor lighting and advertising boards. LA-1055

Wall bracket with two swivelling LED spotlights. The luminous intensity corresponds to about 80 watts of halogen light.
Beam angle: 120
Wide, uniform light emission approx. 200cm/350cm diameter Including long-life LED lamps 50000 hrs.
Light colour: 4500K white (for a small surcharge we also deliver in 3000K warm white)
Connection voltage: 230V 50Hz
Power consumption: 20W
Material: aluminium, grey
incl. 2x connection cable 2m with safety plug mounted on the spotlights.
Protection class: IP65
Arm length: 100cm
Weight: 3,55 kg



LED Sign-Board Light Colour-Mix 30W RGB

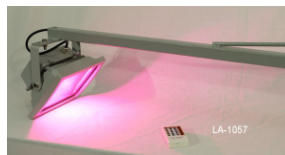

Bright LED projector with bracket. With remote control for any colour setting and illumination for billboard or advertising sign. LA-1057-1

Energy-saving LED floodlight with adjustable tilt angle. With the included remote control, you can adjust the brightness or any colour or white light. You can set automatic, smooth colour transitions. Stepless colour mixing with over 1 million different shades. The light intensity corresponds to about 300 watts of halogen light. Includes long-life RGB Power LED 50000 hrs.
Light emission: 120° very wide
Connected voltage: 230V 50Hz
Power consumption: 32 Watt
Material: die-cast aluminium, grey powder-coated.
Protection class: IP65
Arm length: 100cm
Weight: 3,55 kg

Solar advertising sign lighting



Solar Signboard Lighting



Lighting for advertising sign or object. LED floodlight, solar panel, battery and control unit.
LA-1058

With lighting control: automatic switch-on at darkness.
Light duration until sunrise or programmable, also with midnight break.
Monocrystalline solar panel 100Wp with tempered glass cover, hailproof.
Maintenance-free lead-gel battery with a service life of 6-10 years.
High-intensity LED spotlight with bracket.
The light intensity corresponds to about 60 Watt halogen light.
Light beam angle: 80° (other beam angles on request.)
Includes long-life LED lamps 50000 hrs.
Light colour: 4000K cool white (for a small surcharge we also supply 3000K warm white)
Power consumption 10W / 20W
Material: aluminium, silver-grey
Protection class IP65
Arm length 100cm
Connection cable 200cm

Version 8h for approx. 8 hrs. daily burning time and 33 hrs. self-sufficient operation,
Version 12h for approx. 12 hours daily burning time with 40 hours max. continuous operation with fully charged battery.

The floodlight is attached to the top edge of the sign using the bracket supplied. If desired, we can supply a ground spike instead.
Solar module and battery box are separate and can be fixed nearby.
Horizontal braces must be available behind the sign to attach the solar module and spotlights, or a lattice mast, etc.
Alternatively, these components can also be fixed to another mast or adjacent building.
Robust plastic housing for ground installation or surface mounting to accommodate the battery and control unit. Incl. cable and fixing material.
We would be happy to put together an individual set for you.

Dimensions:
Battery box: 390 x 390 x 400mm
Solar panel: 8h: 1490 x 676, thickness 40mm / 12h: 1650 x 951 x 46mm
Weight: 37 kg



PV Solar Billboard Light LED Bar 1m



With LED light bar, solar panel, battery and automatic light controller. Up to 1.5m advertising board width.
LA-1059

With automatic lighting control, programmable, also with midnight break. Maintenance-free lithium-iron battery with approx. 10-year service life. Bright LED light strip, swivelling

The control switches the lighting on automatically at dusk and off again at dawn.

again at dawn.

If desired, a night interruption can be programmed, to ensure safe operation even in winter.

The system consists of two components that can be mounted together or separately and are connected by cables:

1) Solar module with the luminaire unit.

This is attached to the top edge of the sign with the enclosed bracket.

The solar module can be tilted forwards and backwards to set the optimum illumination angle of the sign.

Furthermore, the solar module also serves as rain protection for the advertising panel.

2) Robust aluminium housing with battery and control unit.

For mounting as desired, horizontally or vertically, for example directly below the PV module.

Solar module specifications:

Monocrystalline silicon with very high efficiency Tempered protective glass, hail-resistant.

This high-quality module technology guarantees charging even under cloudy skies.

Efficiency: > 19%

Output: 80Wp (approx. 120Wp for the 12h version)

Life expectancy: approx. 20 years

Dimensions:

8h: Approx. 1000 x 510, thickness 35mm

12h: Approx. 1200 x 510 x 35mm

Battery memory:

Battery type: Lithium-ion LiFePo4 battery.

For solar cycle operation

Life approx. 8 - 10 years / 20°C

Function also at low temperatures.

Depending on the desired lighting duration, or for greater operational safety in autumn or winter, we offer this lighting in the following versions:

8h) 8 hours nocturnal lighting duration after a sunny day (33 hours self-sufficient operating time)

12h) 12 hours of night-time illumination (40 hours max. continuous operation with fully charged battery).

Aluminium housing IP66 for any mounting behind the billboard or under the solar panel.

Dimensions: 650 x 80 x 40mm

Optionally, we can also supply the system separately, so that the solar module can be placed elsewhere,

e.g. behind the advertising panel, on a mast or on a neighbouring house roof, etc.

We would be happy to put together an individual set for you.

Weight: 27 kg



PV Solar Billboard Lighting Set up to 3m

With 2 Power LED floodlights, solar panel, battery and automatic light controller. Up to 300cm advertising board width.
 With automatic lighting control, programmable, also with midnight break. The two spotlights are fixed to the top edge of the sign with the outriggers supplied. The solar module and battery box are usually attached to the back of the billboard. To attach the solar module and spotlights, horizontal braces must be provided behind the panel, or a lattice mast, etc., must be provided. Alternatively, these components can also be attached to another pole or neighbouring building. We would be happy to put together an individual set for you.

General technical data:

Illuminated area: width approx. 3 metres, height 50 - 250cm
 Ambient temperature: -20°C ~ +55°C
 Protection class: III safety extra-low voltage
 Marks of conformity: CE, RoHS, WEEE
 20 year availability guarantee for spare parts.

Luminaire head specification:

2 pcs. LED luminaire head made of aluminium, black
 LED lamp: SMD chipset
 LED power: 10W each
 Energy efficiency class B
 Light colour 4000K neutral white (on special order also 3000K warm white or 5000K cool white).
 No UV radiation for reduced insect attraction
 Luminaire efficiency: > 100 lm/w
 Luminous flux Lumen: 1000 Lm
 LED life approx. 40,000 hours
 Protection class: IP65
 Wall bracket: 2 pcs. steel bracket, hot-dip galvanised, length: 90 cm

Luminaire control:

Smart microprocessor control with infrared programming option.
 Automatic switch-on at sunset and switch-off at sunrise. (Switching level adjustable)
 Adjustable interruption during late night and switching on again in the morning to extend the lighting duration in bad weather.
 The charge controller settings are preset by us according to customer requirements.
 If you would like to change settings, you will need the S-SOLS29 remote control. We will be happy to help you decide on the correct presets. All functions are pre-programmed by us free of charge, depending on the project and customer requirements, so that the luminaire is ready for operation immediately after installation.
 Temperature-optimised battery charging and trickle charging to protect the batteries.
 Overvoltage and deep discharge protection for battery.
 Reverse polarity and short circuit protection. Additional fuse.
 Protection class: IP66
 5 years warranty

Solar module specifications:

Monocrystalline silicon with very high efficiency Tempered protective glass, hail-resistant.
 This high-quality module technology ensures charging even in overcast conditions.
 Efficiency: > 19%
 Output: 130Wp (approx. 180Wp for the 12h version)
 Life expectancy: approx. 25 years
 Dimensions:
 8h: approx. 1160 x 676, thickness 35mm
 12h: Approx. 1480 x 668 x 35mm

Battery memory:

Battery type: Lithium-ion LiFePo4 battery.
 For solar cycle operation
 Life approx. 8 - 10 years / 20°C
 Function also at low temperatures.
 Depending on the desired lighting duration, or for greater operational safety in autumn or winter, we offer this lighting in the following versions:
 8h) 8 hours nocturnal lighting duration after a sunny day (33 hours self-sufficient operating time)
 12h) 12 hours nocturnal light duration (40 hours max. continuous operation with fully charged battery).

Battery box:

IP66 aluminium housing for any mounting behind the billboard or under the solar panel.

Dimensions: 600 x 80 x 80mm

Scope of delivery:

2 x wall bracket with spotlight and connection cable (mounted).

Solar module with connection cable Mounting bracket for mounting the solar module on a wall, a support or on the ground

Battery box

Connection box for solar control

LA-1060



Mobile PV Solar Billboard Lighting Set

Plug-in, portable lighting for construction site or mobile event. With 2 LED floodlights, solar panel, battery and control unit. For billboards up to 300cm wide and 3m high. With automatic lighting control, programmable, even with midnight break. The two spotlights are attached to the upper edge of the sign with the supplied arms. Solar modules and battery box are usually attached to the back of the billboard. For fixing the solar module and the spotlights horizontal struts must be present behind the panel, or a lattice mast, etc. Alternatively, these components may also be attached to another mast or adjacent building. We are happy to put together an individual set for you.

General technical data:
 Illuminated area: width about 3 meters, height 50 - 250cm
 Ambient temperature: -20 °C ~ + 55 °C
 Protection class: III Protective extra-low voltage
 Test mark: CE, RoHS, WEEE
 20-year availability guarantee for replacement parts.

Lamp head specification:
 2 pcs. LED luminaire head made of aluminum, light gray
 LED lamp: SMD chipset
 LED power: 10W each
 Energy efficiency class A +++
 Light color 4000K neutral white (on special order also 3000K warm white or 5000K cool white).
 No UV radiation for reduced insect attractiveness
 Luminous efficiency: > 100 lm / w
 Luminous flux lumen: 1000 Lm
 LED life about 40,000 hours
 Protection class: IP65

Light Control:
 Smart microprocessor control with infrared programming option.
 Automatic switch-on at sunset and switch-off at sunrise. (Switching level adjustable)
 Adjustable interruption during late night and back on in the morning to extend the duration in bad weather.

The charge controller settings are preset by us according to customer requirements. If you want to change settings, you need the remote control S-SOLS29. We will gladly help you to decide on the right presets. All functions are preprogrammed by us free of charge, depending on the project and customer request, so that the luminaire is ready for operation immediately after assembly. Temperature-optimized battery charging and trickle charging to conserve batteries. Overvoltage and deep discharge protection for battery. Reverse polarity and short circuit protection. Additional fuse
 Protection class: IP66
 5 years warranty

Solar module specifications:
 Monocrystalline silicon with very high efficiency
 tempered protective glass, hailproof
 This high quality module technology also ensures charge in overcast skies.
 Efficiency: > 17%
 Power: 130Wp (180Wp at the 12h version)
 Life expectancy: approx. 25 years
 Dimensions: 8h: 1160 x 676, thickness 35mm / 12h: 1480 x 668 x 35mm

Battery storage:
 Battery Type: Lead Gel 12V, maintenance-free, longlife.
 For solar cycle operation
 Lifetime approx. 6 - 10 years / 20 °C
 Function even at low temperatures.
 For an extra charge: Lithium-ion LiFePo4 battery
 Depending on the desired lighting duration, or for higher reliability in autumn or winter, we offer this lighting in the versions:
 8h) 8 hours nocturnal lighting after a sunny day (33 hours autarkic operating time)
 12h) 12 hours of nocturnal illumination (40 hours max continuous operation with fully charged battery).

Battery box:
Light gray ABS housing IP66 (walk-in version) for free installation or for
ground installation:
Dimensions: 390 x 390 x 400mm

Wall bracket:
2 pcs. Steel outriggers, hot-dip galvanized
Length: 90 cm
LA-1060M



PV Solar Advertising-Board Lighting Bar 3m



Billboard lighting with a long LED strip, solar modules, battery and control. Up to 300cm wide and 2m high.
LA-1061

With automatic lighting control, programmable, even with midnight break. High-intensity LED light strip 300cm long which runs above the entire width of the sign.

Fastened with 2 arms 20 - 80 cm in front of the board.

On request, we also manufacture in other lengths.

The light strip is attached to the upper edge of the sign with the included small arms.

Solar modules and battery box are usually attached to the back of the billboard.

For fixing horizontal struts must be present behind the panel, or a lattice mast, etc.

Alternatively, these components may also be attached to another mast, floor or adjacent building.

We are happy to put together an individual set for you.

General technical data:

Illuminated area: width about 3 meters, height 50 - 250cm

Ambient temperature: -20 ° C ~ + 55 ° C

Protection class: III Protective extra-low voltage

Test mark: CE, RoHS, WEEE

20-year availability guarantee for replacement parts.

Luminaire strip Specification:

Strip made of aluminum profile, natural, 300cm

LED: SMD chipset

LED power: 18W

Energy efficiency class A +++

Light color 4000K neutral white (on special order also 3000K warm white or 5000K cool white).

No UV radiation for reduced insect attractiveness

Luminous efficiency: > 100 lm / w

Luminous flux lumen: 1800 Lm

LED life about 40,000 hours

Protection class: IP65

Light Control:

Smart microprocessor control with infrared programming option.

Automatic switch-on at sunset and switch-off at sunrise. (Switching level adjustable)

Adjustable interruption during late night and back on in the morning to extend the duration in bad weather.

The charge controller settings are preset by us according to customer requirements.

If you want to change settings, you need the remote control S-SOLS29.

We will gladly help you to decide on the right presettings.

All functions are preprogrammed by us free of charge, depending on the project and customer request, so that the luminaire is ready for operation immediately after assembly.

Temperature-optimized battery charging and trickle charging to conserve batteries.

Overvoltage and deep discharge protection for battery.

Reverse polarity and short circuit protection.

Additional fuse

Protection class: IP66

5 years warranty

Solar module specifications:

Monocrystalline silicon with very high efficiency

tempered protective glass, hailproof

This high quality module technology also ensures charge in overcast skies.

Efficiency: > 16%

Power: 2x 80Wp (2x 150Wp at the 12h version)

Life expectancy: approx. 25 years

Dimensions: 8h: 2x 1000 x 510, thickness 35mm / 12h: 2x 1460 x 664 x 35mm

Battery storage:

Battery Type: Lead Gel 12V,

maintenance-free, longlife.

For solar cycle operation

Lifetime approx. 6 - 10 years / 20 ° C

Function even at low temperatures.

For an extra charge: Lithium-ion LiFePo4 battery
 Depending on the desired lighting duration, or for higher reliability in autumn or winter, we offer this lighting in the versions:
 8h) 8 hours nocturnal illumination after a sunny day (33 hours autarkic operating time)
 12h) 12 hours of nocturnal illumination (40 hours max continuous operation with fully charged battery).

Battery box:
 Robust plastic housing for installation in the floor or wall mounting for holding the battery and the controller.
 Incl. Cable and mounting material.
 Dimensions: 390 x 390 x 400mm

Wall bracket:
 2 pcs. Outrigger made of steel, length 100cm, color silver grey
 Weight: 121 kg



PV Solar Advertising-Board Lighting Bar 5m

Billboard lighting with a long LED strip, solar modules, battery and control. Up to 500cm wide and 2m high.
 LA-1062

Sign Board Lighting



LED Advertising-Board Lighting Bar 200cm



Long and bright power LED bar for 2 meter billboard width.
 LA-1067

Bright LED light strip that runs at a distance of 1 metre above the entire width of the sign.
 The light strip is swivel-mounted on several wall brackets.
 Length 200 cm (special lengths on request).

Light colour white (on special request also warm white, blue, red, yellow, green or with RGB colour change)
 Power consumption 15 watts
 Connection voltage 230V
 LED power supply included
 Approx. 50000 hours operating time
 Weatherproof aluminium rail 20 x 20mm with embedded LED light strip.

Including 2 wall brackets grey with 100cm length and 4m connection cable.

We would be happy to put together an individual set for you.
 Weight: 6,5 kg



LED Advertising-Board Lighting Bar 300-600cm

Long and bright power LED bar for 3 meter billboard width. Can be extended up to 6 meter.
 LA-1068







Wall Bracket 100cm for Outdoor Wall Lights



Mounting arm for spotlights and lamps up to 5 kg. Indoor and outdoor
 Welded steel, surfaced.
 Available in black or grey.
 Mounting plate: 120 x 120mm
 LA-1096











Wall Bracket Kelvin 90cm for heavy Floodlight

Particularly stable mounting arm for heavy outdoor luminaires, floodlights and spotlights.
 LA-1099

Exterior Wall Lights

	<p>LED House Wall Uplight and Downlight Cambur</p>	<p>Modern and energy saving house wall light with 9 watt. LA-1116</p> <p>With High-Power LED 9 W shining upwards and downwards. Pleasant light colour warm white 4000K Beam angle 17 Service life approx. 50,000 hours ! LEDs are not replaceable. Including LEDs, including ballast. Connection voltage 230V Material die-cast aluminium Protection class IP65 Dimensions: W 75mm, H 160mm, D 85mm Weight: 1,3 kg</p>
	<p>LED Facade Uplight Needle and Downlight</p>	<p>A razor-sharp beam of 3 degrees light goes up and down. Limited number of pieces available. A bright strip of light is projected up and down. Beam angle: 3° downwards + upwards Lighting range up to 7 + 7m. Incl. LED Light color: 6000K cool white Voltage 230V Power 10W Housing: cast aluminum silver gray Dimensions: width 135mm, height 130mm, depth 145mm LA-1122-N</p>
	<p>Myra Wall Halogen Facade Light 50W</p>	<p>Adjustable quartz wall fitting for indoor or outdoor. Swivel 45°, rotatable 340° Suitable for GU10 halogen bulb 50W max. (Please order lamp separately.) Operating voltage 230V Aluminum housing, color silver gray Protection degree IP55, for outdoor Dimensions: L 105mm, W 80mm, D 145mm. Head Ø 70mm LA-1123</p>
	<p>Halogen Wall Light Pillar Outdoor</p>	<p>Halogen house facade fixture for two lamps, max. 2x 75W halogen. LA-1125</p> <p>Suitable for bulb E27 PAR30 75W max, length up to 105mm. Please order lamp separately.</p> <p>Operating voltage 230V Housing aluminium Colour black or silver-grey Protection class IP54 Dimensions: H 260mm, W 172mm d=108mm Weight: 1 kg</p>
	<p>LED Wall Light Pillar Outdoor</p>	<p>Decorative facade luminaire shining upwards and downwards, with 2 LED spotlights. Only small stock left. LA-1125L</p> <p>Energy saving and bright lighting for entrance or house wall. Incl. exchangeable LED lamps E27 2 x 6W.</p> <p>Light colour: 3000K warm white Operating voltage: 230V Power: 12W Aluminium casing Color: Black or silver gray Protection degree: IP54, for outdoor Dimensions: H 260mm, W 114mm Weight: 1 kg</p>

	<p>LED Wall Light Pillar Mini Outdoor</p>	<p>Small, round house facade fixture with two LED lamps, upwards and downwards. LA-1125ML</p> <p>Energy-saving and bright lighting for front door or house wall. Incl. replaceable LED lamps E27 2 x 3W. Light colour: 3000K warm white Operating voltage: 230V Power: 6W Housing: aluminium Colour: silver-grey (on order also black) Protection class: IP54 Dimensions: H 155mm, D 115mm, head Ø 65mm Weight: 0,42 kg</p>
	<p>Zilly Entrance Light with Motion Sensor</p>	<p>Up-down lighting halogen fixture with PIR detector. Made of stainless steel. LA-1130</p> <p>IR detector detection range 120°, up to 6m distance. Luminaire can be equipped with 2 x lamp GU10 max. 35W. Operating voltage 230V Dimensions: Height 180mm, diameter 63mm, depth 115mm Weight: 1 kg</p>
	<p>Solar Sensor LED Wall Light PIR 3,2W</p>	<p>LED solar spotlight 3W for house entrance, house wall, driveway etc. Minimum order quantity: 2 pcs. LA-1134</p> <p>Attractive wall spotlight made of PBT. The outdoor spotlight is supplied complete with warm white LED. At sunset, the luminaire automatically switches on a dim light as an orientation light. As soon as a person enters the area, the lighting is switched on brightly. After about 30 seconds, the light switches back to economy mode. IR detector range 2 - 6m at 120° angle of detection.</p> <p>Brightness: 400 lumen LED: 3000K 3,2W Operating time: 8 - 24 hours with fully charged battery. With solar panel: 2.3W Long-life lithium-ion battery 2000 mAh (replaceable) Protection class: IP65 Dimensions: Width 138mm, D 90mm, H 200mm Weight: 0,6 kg</p>
	<p>Solar Sensor LED Wall Light PIR</p>	<p>Nice solar outdoor wall mount spot lighting fixture with LED and IR-motion detector. For house entrance, pathway or carport. LA-1135-P</p> <p>The outdoor spotlight is supplied complete with cool white LED 6000K.</p> <p>At sunset, the luminaire automatically switches on a dim light as an orientation light. As soon as a person enters the area, the lighting is switched on brightly. After about 30 seconds, the light switches back to economy mode. IR detector range 2 - 6m at 120° angle of detection.</p> <p>Operating time: 12 - 24 hours with fully charged battery. With solar panel: 2W Replaceable battery Attractive wall floodlight made of aluminium and polycarbonate. Protection class: IP65 Dimensions: Width 130mm, D 92mm, H 65mm Weight: 0,18 kg</p>
	<p>Outdoor Wall Sconce Stainless Steel</p>	<p>Low priced inox outdoor light in the design type 1 LA-1140</p> <p>Curved stainless steel lamp for use with standard E27 lamps up to 40W or energy-saving lamps. (Please order bulbs separately). House number set for available on request. Connection voltage 230 V Protection class IP44 Dimensions: Height 300mm, width 225mm, depth 95mm. Weight: 0,8 kg</p>

	<p>House Wall Sconce Baleo</p> 	<p>Outdoor wall lamp made of cast aluminium in silver-grey. Only 1 pc. available LA-1150</p> <p>Die-cast aluminium luminaire for outdoor use according to IP 44. For E27 bulbs max. 100W. (Please order bulbs separately)</p> <p>Wall mounting: Ø 110mm Dimensions: Ø 255mm, height 290mm, D 370mm</p> <p>Floor lamps, lanterns and wall lamps are available in the same design. Weight: 1,5 kg</p>
	<p>Aluminium Outdoor Wall Light Fixture</p> 	<p>Aluminium wall lamp, powder-coated, with frosted glass shade, for outdoor use. LA-1156</p> <p>For smooth, warm light. For energy-saving bulb E27, max. 11 W or ball lamp E27, max. 40 W. Please order lamp extra. Casing aluminium silver-gray Protection degree IP54 Dimensions: Height 22.5 cm, diameter 6.5 cm, 11 cm mount Weight: kg</p>
	<p>Outdoor Wall Light Bowl 25cm</p> 	<p>Front door luminaire or patio luminaire with plastic sphere transparent, half darkened. 250mm LA-1160</p> <p>Globe made of impact-resistant PMMA plastic. Glare-free at the top, black outside, reflective aluminium inside. Please order wall bracket separately. Weight: 0,92 kg</p>
<p>Outdoor Wall Light Bowl 30cm</p>		<p>Transparent plastic sphere for front door, terrace or house wall. Half darkened. 300mm. LA-1161</p>
	<p>Pendant Light Classic black</p> 	<p>Classic pendant lamp made of cast aluminium for indoor or outdoor use. LA-1166</p> <p>Suspension lamp for use with incandescent lamps or energy-saving lamps. (Please order bulbs E27 max. 60W separately). Connection voltage 230 V Material: cast iron black lacquered With 50cm chain and ceiling rose. Dimensions: L 150 mm, W 150 mm, H 290 mm Weight: 1,2 kg</p>
	<p>Garden Wall Light Lantern</p>	<p>Old-style on-mount wall fixture for outdoor. Material Aluminium black Wall lamp for use with standard lamps or energy-saving lamps with E27 base. (Please order bulbs separately). Max. Power 100W Connection voltage 230 V Material: cast aluminium black Lamp head 4-cornered Dimensions: L 300 mm, H 408 mm, Ø 184mm LA-1167</p>
	<p>Pendant Light Classic black</p>	<p>Old-style aluminium die-cast fixture for indoor or outdoor. LA-1175</p> <p>Suspension lamp for use with incandescent lamps or energy-saving lamps. (Please order bulbs E27 max. 60W separately). Connection voltage 230 V Material: cast iron black lacquered With 50cm chain and ceiling rose. Dimensions: L 150 mm, W 150 mm, H 290 mm Weight: 1,2 kg</p>



LED House Wall Sconce Conus



Decorative wall-mounted luminaire, energy-saving.
LA-1190

Available in housing colour silver-grey, anthracite-black, bronze antique.
Please order LED GU10 separately.
Supply voltage 230V
Material cast aluminium,
protection class IP44
dimensions: W 100mm, H 150mm, D 110mm
Weight: 0,67 kg

Outdoor Flood Lights up to 150W



Fluorescent Outdoor Floodlight ACT 52W - 84W



Energy-saving outdoor floodlight quick start for 2x compact fluorescent lamp 26W or 42W.
Asymmetrical light distribution for glare-free building lighting.
For industry, waiting areas, indoors or outdoors.
As bright as 400W halogen. Quality made in EU
LA-1218

Floodlight with built-in, low-loss ballast.
High-quality housing of Italian manufacture.
Applications: Building illumination. Market lighting, courtyard lighting, industrial lighting, high ambient temperatures.

Particularly temperature-resistant.
Fast-starting luminaire with asymmetrical light emission.
Application areas: Indoors and outdoors.
Specially designed for low power consumption and long operating life.





Lamp life approx. 10,000 h
Multiwatt electronic ballast - flicker-free.
Suitable for 2 compact fluorescent lamps 26W, 32W or 42W GX24q (please order separately).
Supply voltage 220V - 240V 50Hz (60Hz on request).
Operating current: 0,36A
Housing: die-cast aluminium, black.
With protection glass and waterproof cable gland.
Protection class: IP66 (jet water protected).
Certificates: EN 60598-1:04, EN 60598-2-5:98.
Dimensions: W 290mm, H 380mm, D 130mm
Weight: 5,2 kg

Accessories for outdoor fixtures



Protection Grill for Square or Mig Floodlight
LA-1226

Stadium Lights and LED Floodlights 600W - 2000W

	Power Flood Light 2000W HID	<p>High-Power luminary fixture for 2000 watt mhd metal halide discharge lamp. LA-1235</p> <p>Eloxated aluminium reflector for extreme high light output (equivalent to 8500 watts halogen).</p> <p>Light distribution: Symmetrical or asymmetrical. Voltage: 400V / 10 amp Suitable for mh discharge lamp 2000 watt E40, HRI-T or HQI-T E40 2000 Watt 8,8A. Start-up time: aprx. 2 - 3 minutes. Lamp life time: Aprx. 8,000 h Max. cable length between ballast and light fixture: 15m Ballast and lamp have to be ordered extra. Housing: Die-cast aluminum, gray coated. hardened protection glass Adjustable hanging bracket. Protection class: IP65 Shock resistance: IK10 Wind load: 0.375 m² Dimensions: Width 652 mm, height 576 mm, depth 303 mm Weight: 19 kg</p>
	HID Flood Light IP 2000W HID Assymmetric	<p>Powerful floodlight with aluminium reflector for maximum light intensity and wide asymmetrical distribution. HQI spotlight 2000 Watt energy-saving - as bright as 8500 Watt halogen light. LA-1239</p>
	Outdoor Flood Light LUX 1000W HID SYM	<p>Large outdoor floodlight for high-pressure lamp with maximum luminous intensity and wide light distribution. Energy-saving HQI technology 1000 Watt - as bright as 4000 Watt halogen light. LA-1247</p> <p>Robust construction, also suitable for emergency lighting or as stadium floodlight. Light cone 60 Suitable for lamp HQI-T, HRI, HPI-T E40 1000 Watt 8,2A Run-up time approx. 2 - 3 minutes. Lamp life 8,000 h (Please order lamp and separate ballast separately.) Operating voltage 220 - 240V / 50Hz / 1000 Watt</p> <p>Housing: die-cast aluminium, light grey coated. Hardened protective glass and temperature-resistant gasket. Protection class IP65 - splash-proof. Mounting by means of swivelling bracket. Dimensions: W 650mm, H 610mm Weight: 19 kg</p>
	Outdoor Flood Light 1000W MH HPS asymmetric	<p>Robust floodlight with maximum luminous intensity and wide, asymmetrical light distribution. For sodium vapour or metal vapour lamps. Excellent efficiency. As bright as 4000 Watt halogen. LA-1248</p>

Outdoor Flood Lights up to 150W



**Outdoor Flood Light Kelvin LUX
150W HID**



Luminaire for 150 watt metal halide discharge lamp MH.
LA-1251-15

Aluminium reflector for symmetrical light emission 60°.
Built-in ballast.
For the longlife metal halide lamp HQI-TS 150W Rx7s.
Please order lamp separately.
Supply voltage: 230V / 50Hz (optionally 230 Volt 60Hz)
Operating current: 0,75A
Starting current: 10 - 15A (0,25 sec.)
Housing: Black die-cast aluminium.
Swivelling mounting bracket.
Dimensions: Width 280, height 210, depth 165 mm.
Protection class IP65
Weight: 4 kg



**Outdoor HID Floodlight Style
150W Symetrical**



Rigid sodium or mh metal halide light fixture 150 watt for outdoor use.
LA-1261S

Powerful and nice outdoor floodlight with symmetrical light distribution.
Special built for low power consumption and long-time operation.
Built-in magnetic ballast, ignitor and lamp holder RX7s.

Suitable for:
HPS sodium lamp NAV-TSX 150 W
(This light source has an excellent efficiency. The generated light is yellow.
Reduced colour rendering.)
or metal halide lamp HQI-TS 150 watts.
(This light source has an excellent efficiency. The light is white and has a
very good colour rendering.)
The lamp has to be ordered extra.

Harmonic distortion THD < 10%
Aluminium die-cast housing gray. With adjustable mounting bracket.
Protection class IP66 waterproof.
CE approval.
Dimensions: w 290 mm, l 380 mm, d 130 mm.
Weight: 5,8 kg



**Sodium Flood Light Marine
Yellow 70W HPSV 2600K**

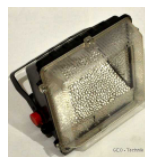

Extremely resistant floodlight with yellow light for outdoor use in sea-harbour,
facade and historical building.
Energy saving sodium lamp technology - as bright as 300w halogen light.
LA-1270-N

Built-in ballast and E27 socket.
The energy-saving sodium vapour lamp has an excellent efficiency.
Protected against salty air or urine or common cleaning agents in animal
stables, slaughterhouses, car washes.
Please order separately: Lamp NAV-E SON-E 70W (yellow light 2600K) or
HQI-E27 (white light).
The spotlight has a black, corrosion-resistant ABS plastic housing with a
swivelling mounting bracket with hole.
Other areas of use: beach, pier, jetty, boat harbour.
Service life of the lamp up to 15000 hours.
Connected voltage: 230V / 50Hz
Operating current: 0,42A
Starting current: 5 - 8A
Protection class IP65, for outdoor use.
Dimensions: W 280mm, H 300mm, D 230mm.
Weight: 3,1 kg



Waterproof HID Flood Light Marine 70W HPSV

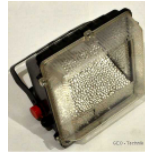

Extremely resistant floodlight for lighting in harbour, park, car wash, zoological garden, animal stable, enclosure.
Discharge lamp spot E27 HID made of impact-resistant plastic, energy-saving. As bright as 300W halogen.
LA-1270-S

Built-in ballast and E27 socket.
The energy-saving sodium vapour lamp has an excellent efficiency.
Protected against salty air or urine or common cleaning agents in animal stables, slaughterhouses, car washes.
Please order separately: Lamp NAV-E SON-E 70W (yellow light) or HQI-E27 (white light).

The spotlight has a black, corrosion-resistant ABS plastic housing with a swivelling mounting bracket with hole.

Other areas of use: beach, pier, jetty, boat harbour.

Lifetime of the lamp up to 15000 hours.

Connected voltage: 230V / 50Hz

Operating current: 0,42A

Starting current: 5 - 8A

Protection class IP65, for outdoor use.

Dimensions: W 280mm, H 300mm, D 230mm.

Weight: 3,1 kg



Outdoor Flood Light Exclu 150W HID



Energy economizing outdoor flood light. 150 watt mh = as bright as 550w incandescent

LA-1272-H

Symmetrical light emission

Built-in ballast and lampholder Rx7s.

The metal halide lamp has excellent efficiency and a long service life.

Please order separately: HQI-TS 150W lamp.

The spotlight has a black cast aluminium housing with a swivelling mounting bracket with hole.

Dimensions: L 410mm, W 270mm

Weight: 6 kg

Accessories for outdoor fixtures



Louvre for Industry Floodlight 70 /150W
LA-1295



Ground Spike for Floodlight small
LA-1310



Ground Spike for Floodlight large
LA-1311

Narrow Beam Spotlights Outdoor



High Intensity Spotlight 1000W MH-TD IP65



Outdoor spot light to illuminate objects in up to 200 m distance.
1000 watt metal halide discharge - as bright as 4000w halogen. Waterproof LA-1326-8

Narrow beam spread 12° (optional 35°)
Metal halide, for outdoor use.
By the double sided lamp holder this fixture is shockproof and vibrationproof.

To be used with mh discharge lamp 1000 watt K12S 187mm.
(Lamp not included)

Operating voltage: 220V - 230V 50 Hz

Igniter box: in nylon fiber glass standard equipment, applied directly on the housing.

The ballast gear has to be ordered extra.

GORE® Protective Vents system: supplied as standard.

Housing: Aluminium die-cast, grey, with adjustable mounting bracket.

Paintwork: thermosetting polyester powder, prior degreasing and phosphochromatizing process that will ensure an extremely high resistance to chemical and atmospheric agents.

Bracket: 4 mm thickness shaped steel with hot-dip galvanizing final treatment.

Large pure aluminum reflector.

Glass: extra clear 5 mm tempered.

Protection degree IP66

Shock proof: IK10

Ambient temperature: - 25 °C bis + 45 °C

Certifications: ENEC, CE

Wind load: 0.206 m²

Dimensions: Ø 505, L 520 mm, d 300 mm

Weight: 14,1 kg

Stadium Lights and LED Floodlights 600W - 2000W



High Intensity Spot Light IP 2000W HID



Narrow beam projector to illuminate objects in 300m distance and more.
2000 watt metal halide discharge - as bright as 8000w halogen. Waterproof LA-1329

Concentrated light beam 12° (optional 35°).

Metal halide, for outdoor use.

By the double sided lamp holder this fixture is shockproof and vibrationproof.

GORE® Protective Vents system: supplied as standard.

To be used with mh discharge lamp 2000 watt K12s-36.

(Lamp not included)

Operating voltage: 380V - 400V 50 Hz

Igniter box: Nylon fiber glass standard equipment, applied directly on the housing.

The ballast gear has to be ordered extra.

Housing: Aluminium die-cast, grey, with adjustable mounting bracket.

Paintwork: Thermosetting polyester powder, prior degreasing and phos-phochromatizing process that will ensure an extremely high resistance to chemical and atmospheric agents.

Bracket: 4 mm thickness shaped steel with hot-dip galvanizing final treatment.

Reflector: Large pure aluminum

Glass: Extra clear 5 mm tempered.

Protection degree IP66

Shock proof: IK10

Ambient temperature: - 25 °C bis + 45 °C

Certifications: ENEC, CE

Wind load: 0.206 m²

Dimensions: Ø 505, L 520 mm, d 300 mm

Weight: 13,1 kg

Accessories for outdoor fixtures



Circular Visor for Square Spot LEG Act 70/150W
LA-1365



Circular Visor for Square LEG MIG 250/400W
LA-1375



Deflector Clip for MX Spotlight
LA-1394



Wall Bracket For Vano long 2 pcs.
LA-1409-2

Architectural and Facade Lighting



LED Facade Wall Washer RGB 70W



For low-energy illumination of building. With colour changing and dimming.
LA-1420

Includes 18 high-performance LEDs for brilliant colors.
Lighting distance approx 15 meters,
Light emission: 40 ° (on order also 10 °)
LED life: 50,000 hrs
Stepless dimming and many color change transitions.
Control: Automatic or Master-Slave or DMX-512
Integrated power supply,
Operating voltage: 100V - 240V
Temperature range: -20°C ... +40°C.
Spill-resistant, IP65 protection
Robust aluminum housing black.
Dimensions: w 380 mm, d 195 mm, h 280 mm
Weight: 4,5 kg

LED Floodlights and Spotlights Outdoor max. 50W



Outdoor LED Flood Light RGB 10W IR Remote

Coloured LED floodlight 10 Watt - as bright as 80 Watt halogen light.
Floodlight for outdoor lighting, with infrared remote control.
LA-1450I



Outdoor LED Flood Light RGB 50W RF Remote

Coloured LED spotlight 50 Watt - as bright as 400 Watt halogen light. For outdoor lighting, with radio remote control.
LA-1455







LED Flood Light Joy Outdoor 12W IP66



Elegant and bright LED spotlight for indoor and outdoor lighting. Made in the EU.
LA-1512

The brightness is comparable with 35W metal halide
Very wide light distribution: 120° for direct illumination
Ideal for wide illumination at close range. For example: Facade, workshop, sign board.
Luminous flux: 2210 lm
Light colour: 4000K pure white
Power: 12W
Voltage: 220-240V
Frequency: 50-60Hz
Wind surface: 0.04 m²
Protection: IP66
Tempered protection glass
Silicone gaskets
Casing from aluminium die-cast
Painting: Anthracite RAL 7039 (on special order black, silver or white)
Dimensions: Length 256mm, width 196mm, thickness 51mm
Weight: 2,61 kg

	<p>LED Flood Light Joy Outdoor 18W IP66</p>	<p>Elegant and bright LED luminary for indoor or external lighting. Made in EU. LA-1514</p>
		<p>The brightness is comparable with 50W metal halide Very wide light distribution: 120° for direct illumination Ideal for wide illumination at close range. For example: Facade, workshop, sign board. Luminous flux: 3040 lm Light colour: 4000K pure white Power: 17.5W Voltage: 220-240V Frequency: 50-60Hz Wind surface: 0.04 m² Protection: IP66 Tempered protection glass Silicone gaskets Casing from aluminium die-cast Painting: Anthracite RAL 7039 (on special order black, silver or white) Dimensions: Length 256mm, width 196mm, thickness 51mm Weight: 2,61 kg</p>

	<p>LED Flood Light Joy Outdoor 32W IP66</p>	<p>Elegant and bright LED luminary for indoor or external lighting. Made in EU. LA-1516</p>
		<p>The brightness is comparable with 100W metal halide Very wide light distribution: 120° for direct illumination Ideal for wide illumination at close range. For example: Facade, workshop, sign board. Luminous flux: 5000 lm Light colour: 4000K pure white Power: 32W Voltage: 220-240V Frequency: 50-60Hz Wind surface: 0.04 m² Protection: IP66 Tempered protection glass Silicone gaskets Casing from aluminium die-cast Painting: Anthracite RAL 7039 (on special order black, silver or white) Dimensions: Length 256mm, width 196mm, thickness 51mm Weight: 2,61 kg</p>

Outdoor Flood Lights up to 150W

	<p>LED Flood Light SkyTor for Outdoor 52W IP66</p>	<p>Elegant and bright LED luminary for indoor or external lighting. Made in EU. LA-1520</p>
		<p>The brightness is comparable with 100W metal halide There are different light distributions available: AS = Asymmetrical shape 80° for facade or parking lot Luminous flux: 5400 lm Light colour: 4000K pure white Power: 52W Voltage: 220-240V Frequency: 50-60Hz Wind surface: 0.07 m² Protection: IP66 Tempered protection glass Silicone gaskets Casing from aluminium die-cast Painting: Silver grey RAL 9006 Dimensions: Length 375mm, width 245mm, thickness 65mm Weight: 4,2 kg</p>

LED Floodlights and Spotlights Outdoor max. 50W



LED Flood Light COB SkyTor for Outdoor 25W IP66



Elegant and bright LED spotlight for indoor and outdoor lighting. Made in the EU.

LA-1524

Only a few left in stock

The brightness corresponds to about 50W HQI or 300W halogen light.

Light emission very wide 120° Ideal for wide illumination at close range, e.g. facade, workshop, advertising sign.

Luminous flux: 3420 lm

Light colour: 4000K neutral white

Power: 27W

Voltage: 220-240V

Frequency: 50-60Hz

Windage area 0,07 m²

Protection class: IP66

Hardened protective glass Silicone gaskets

Housing made of cast aluminium

Colour: Silver grey RAL 9006

Dimensions: Length 375mm, width 245mm, thickness 65mm

Weight: 4,2 kg

Narrow Beam Spotlights Outdoor



Small LED Spotlight Outdoor 12V 6W



Powerful LED spotlight 12 Volt, in aluminium housing. For indoor and outdoor use.

LA-1534

For boat, ship, truck, car, outdoor, solar operation, garden lighting ...

Symmetrical light emission 40°.

Including 3 Power LEDs 3 Watt each

Amazingly bright light with low power consumption

Light colour 3000K warm white

Luminous flux: 500 - 550 Lm

Operating voltage: 12V DC / 580mA

Power consumption 6 Watt

Dimmable with LED dimmer

Lifetime 50000 hours.

Please order LED transformer or ballast separately.

With rubber cable 1m

Protection class IP65

Housing: aluminium silver, with swivelling mounting bracket.

Dimensions: Front 73mm, rear 68mm, length 77mm, total height 97mm.

Weight: 0,4 kg



Small LED Spotlight Outdoor 9W



Waterproof LED spot 9 watt with the power of 80 watt halogen light. Round aluminium light

LA-1535

For façade lighting, small advertising signs, garden lighting, plant lighting in swimming pools ...

As bright as 90 Watt halogen light.

Bundled light emission 30° or 60° .

Includes 3 power LEDs of 3 watts each

Amazingly bright light with low power consumption

Light colour: 4000K natural white

Luminous flux: 700 - 750 Lm

Operating voltage: 90 - 240V AC

Power consumption: 10 Watt

Not dimmable

Lifetime 50000 hours.



With rubber cable 1m

Protection class IP65



Housing: aluminium silver, with mounting bracket swivelling.

Dimensions: Front 73mm, back 68mm, length 80mm, total height 97mm.



Weight: 0,4 kg

	<p>Small LED Spotlight Outdoor 6W</p>	<p>Waterproof LED spot 6 watt 230 volt with the power of 50 watt halogen light. LA-1536</p>
		<p>For boat, ship, truck, car, outdoor, solar power, garden lighting ... Wide beam shape 40°. Including 3 power LED 3 watt Light colour 3000K warmwhite Lumen: 500 - 550 Lm Operating voltage: 220 - 240V AC Power consumption: 6 Watt Average life time: 50000 h LED transformer or driver has to be ordered extra. With rubber cable 1m Protection class: IP65 Housing: Aluminium silver, with adjustable mounting bracket. Dimensions: Front 73 mm, backside 68mm, length 77mm / total height 97mm Weight: 0,4 kg</p>

LED Floodlights and Spotlights Outdoor max. 50W

	<p>LED Floodlight 10W Outdoor</p>	<p>Powerful LED spotlight with power LEDs and lenses for directional light. For advertising sign or garden. Discontinued item - only 1 available. LA-1541 Bundled light distribution 40°. Includes 6 Hi-Power LEDs standard white. Remaining stock available in 4000K natural white or 3000K warm white. Built-in ballast. Operating voltage: 230V 50 / 60Hz Power consumption: 10 Watt Lifetime 50000 hours Protection class IP44 Mains cable 1.3m with safety plug. Housing: die-cast aluminium grey, with swivelling mounting bracket. Dimensions: Width 140, height 150, depth 95 mm. Weight: 0,75 kg</p>
	<p>Outdoor LED Flood Light 10W</p>	<p>LED projector 10 watt, with the brightness of 80 watt halogen light. LA-1543-60</p>

Narrow Beam Spotlights Outdoor

	<p>Outdoor LED Spotlight RGB 18W WiFi</p>	<p>Very powerful LED projector IP66 with colour changing. 18 watt, with the force of 200 watt halogen light. LA-1544 Smooth, bright narrow beam shape 30° With 6 high performance LEDs. In 7m distance: Beam circle 450cm diameter. Light color: RGB The brightness is comparable to a 250W halogen lamp. The suitable 24 V DC RGB controller must be ordered extra. Operating voltage: 24V DC Power consumption: 18 watts dimming option on surcharge Housing: die-cast aluminum mounting bracket with swivel. Protection class IP65 Width 210, height 205, depth 62 mm. Weight: 3,3 kg</p>
		

LED Floodlights and Spotlights Outdoor max. 50W

	<p>Outdoor LED Floodlight 30W grey</p>	<p>Very bright LED spotlight 30 Watt 230V, with the light intensity of 200 Watt halogen light. LA-1546G</p>
---	---	---



Outdoor Power LED Floodlight 50W IP65

Very powerful LED spotlight 50 Watt 230V, with the light intensity of 500 Watt halogen light.
 Stock: 1 piece
 LA-1547

Very wide and uniformly bright beam 120°. With power LEDs.

Light colour 4000 K neutral white (3000K warm white on order).
 Luminous flux 4700 Lm - comparable to a 150W metal halide high-pressure lamp.

Built-in ballast.
 Operating voltage: 230V 50 / 60Hz
 Power consumption: 55 Watt
 Housing: die-cast aluminium grey, with swivelling mounting bracket.
 Protection class: IP65
 Dimensions: Width 220, height 220, depth 145 mm.
 Weight: 4,1 kg

LED Outdoor Flood Lights 180W - 500W and Halogen



LED Flood Light 220W Outdoor



Bright LED floodlight 220 Watt IP65, with wide beam. Light intensity of 2000 Watt halogen light.
 LA-1557-20

Light distribution:	140°
Lifetime:	50000h
Light colour:	4000K natural white.
Light intensity	28600 Lm - similar to 2500 watt halogen lamp.
Included PWM LED driver.	
Operating voltage:	230V AC 50 - 60Hz.
Power consumption:	220 Watt
Ambient temperature:	- 20°C ... +40°C (on surcharge -45°C ... +40° C)
Housing:	Aluminium die-cast black, with adjustable mounting bracket.
Protection degree	IP65
Dimensions:	Width 400, height 365, depth 132 mm
Weight:	6 kg

LED Floodlights and Spotlights Outdoor max. 50W



LED Floodlight Projector 35W with lens optics IP66



Robust, powerful outdoor floodlight with lens optics - produced in EU
 Replaces the old floodlight fixtures mh 70W hqi, or hps, symmetric or asymmetric.
 LA-1559-03

Light emission optional:
 140° very wide
 or with asymmetrical lens optics for uniform task lighting.

With Power LED Osram	
Luminous flux reduction:	L90B10 50000h
Service life :	approx. 100000 hrs.
Light colour:	4000K neutral white
Luminous flux:	5300 Lm - comparable to a 70W metal halide high pressure lamp.
Built-in Philips driver	
Operating voltage:	202 - 254V 50 / 60Hz
Power consumption:	35 Watt
With short connecting cable and waterproof cable coupling	
With pressure compensation valve	
Permissible ambient temperature:	- 20°C ... +50°C (against surcharge also -45°C ... +55°C)
Housing:	die-cast aluminium, grey, with swivelling mounting bracket.
Wind load:	0.023m ²
Protection class:	IP66
Impact resistance:	IK08
Dimensions:	Height 383, width 251, depth 60 mm
Weight:	3,6 kg

Outdoor Flood Lights up to 150W



LED Floodlight Projector 55W with lens optics IP66



Robust, powerful outdoor floodlight with lens optics - produced in EU
Replaces the old floodlight fixtures mh 70/150W hqi, or hps, symmetric or asymmetric.
LA-1559-05

Light emission optional:
without lenses 140° very wide
RS23 23° symmetric spot
RS48 48° symmetric medium
or with asymmetrical lens optics for uniform task lighting.

With Power LED Osram
Luminous flux reduction: L90B10 50000h
Service life : approx. 100000 hrs.
Light colour: 4000K neutral white (on demand 3000K or 5700K)
Luminous flux: 7300 Lm - comparable to a 150W metal halide high pressure lamp.
Built-in Philips driver
Operating voltage: 202 - 254V 50 / 60Hz
Power consumption: 55 Watt
With short connecting cable and waterproof cable coupling
With pressure compensation valve
Permissible ambient temperature: - 20°C ... +50°C (against surcharge also -45°C ... +55°C)
Housing: die-cast aluminium, grey, with swivelling mounting bracket.
Wind load: 0.023m²
Protection class: IP66
Impact resistance: IK08
Dimensions: Height 383, width 281, depth 60 mm
Weight: 3,6 kg



LED Floodlight Projector 75W with lens optics IP66



Robust, powerful outdoor floodlight with lens optics - produced in EU
Replaces the old floodlight fixtures mh 150W hqi, or hps, symmetric or asymmetric.
LA-1559-07

Light emission optional:
140° very wide
or with asymmetrical lens optics for uniform task lighting.

With Power LED Osram,
Luminous flux reduction: L90B10 50000h
Service life : approx. 100000 hrs.
Light colour: 4000K neutral white (on demand 3000K or 5700K)
Luminous flux: 11700 Lm - comparable to a 150W metal halide high pressure lamp.
Built-in Philips driver.
Operating voltage: 202 - 254V 50 / 60Hz
Power consumption: 79 Watt
With short connecting cable and waterproof cable coupling
With pressure compensation valve
Permissible ambient temperature: - 20°C ... +50°C (against surcharge also -45°C ... +55°C)
Housing: die-cast aluminium, grey, with swivelling mounting bracket.
Wind load: 0.023m²
Protection class: IP66
Impact resistance: IK08
Dimensions: Height 383, width 281, depth 60 mm
Weight: 4,4 kg



LED Floodlight Projector 140W with lens optics IP66



Robust, powerful outdoor floodlight with lens optics - produced in EU
Replaces the old floodlight fixtures mh 250W hqi, or hps, symmetric or asymmetric.
LA-1559-14

Light emission optional:
140° very wide

RS23 23° symmetrisch Spot
RS48 48° symmetrisch mittel

or with asymmetrical lens optics for uniform task lighting.

With Power LED Osram,

Luminous flux reduction: L90B10 50000h

Service life : approx. 100000 hrs.

Light colour: 4000K neutral white (on demand 3000K or 5700K)

Luminous flux: 18500 Lm - comparable to a 250W metal halide high pressure lamp.

Built-in Philips driver.

Operating voltage: 202 - 254V 50 / 60Hz

Power consumption: 140 Watt

With short connecting cable and waterproof cable coupling

With pressure compensation valve

Permissible ambient temperature: - 20°C ... +50°C (against surcharge also -45°C ... +55°C)

Housing: Die-cast aluminium, grey, with swivelling mounting bracket.

Wind load: 0.028m²

Protection class: IP66

Impact resistance: IK08

Dimensions: Height 442, width 347, depth 64 mm

Weight: 6 kg

LED Outdoor Flood Lights 180W - 500W and Halogen



LED Floodlight Projector 180W with lens optics IP66



Robust, powerful outdoor floodlight with lens optics - produced in EU
Replaces the old floodlight fixtures mh 400W hqi, or hps, symmetric or asymmetric.
LA-1559-18

Light emission optional:
without lenses 140° very wide

RS23 23° symmetric spot

RS48 48° symmetric medium

or with asymmetrical lens optics for uniform task lighting.

With Power LED Osram,

Luminous flux reduction: L90B10 50000h

Service life : approx. 100000 hrs.

Light colour: 4000K neutral white (on demand 3000K or 5700K)

Luminous flux: 23000 Lm - comparable to a 400W metal halide high pressure lamp.

Built-in Philips driver.

Operating voltage: 202 - 254V 50 / 60Hz

Power consumption: 180 Watt

With short connecting cable and waterproof cable coupling

With pressure compensation valve

Permissible ambient temperature: - 40°C ... +50°C (against surcharge also -45°C ... +55°C)

Housing: die-cast aluminium, grey, with swivelling mounting bracket.

Wind load: 0.036m²

Protection class: IP66

Impact resistance: IK08

Dimensions: Height 442, width 347, depth 64 mm

Weight: 8 kg



LED Floodlight Projector 220W with lens optics IP66



Robust, powerful outdoor floodlight with lens optics - produced in EU
Replaces the old floodlight fixtures mh 400W hqi, or hps, symmetric or asymmetric.

LA-1559-20

Light emission optional:

140° very wide

or with asymmetrical lens optics for uniform task lighting.

With Power LED Osram,

Luminous flux reduction:

L90B10 50000h

Service life :

approx. 100000 hrs.

Light colour:

4000K neutral white (on demand 3000K or 5700K)

Luminous flux:

31000 Lm - comparable to a 400W metal

halide high pressure lamp.

Built-in Philips driver.

Operating voltage:

202 - 254V 50 / 60Hz

Power consumption:

220 Watt

With short connecting cable and waterproof cable coupling

With pressure compensation valve

Permissible ambient temperature: - 40°C ... +50°C (against surcharge also -45°C ... +55°C)

Housing: die-cast aluminium, grey, with swivelling mounting bracket.

Wind load:

0.036m²

Protection class:

IP66

Impact resistance:

IK08

Dimensions:

Height 610, width 420, depth 80 mm

Weight: 8 kg



LED Floodlight Projector 300W with lens optics IP66



Robust, powerful outdoor floodlight with lens optics - produced in EU
Replaces the old floodlight fixtures hps 600W sodium or hgi, symmetric or asymmetric.

LA-1559-27

Light emission optional:

140° very wide

or with asymmetrical lens optics for uniform task lighting.

With Power LED Osram,

Luminous flux reduction:

L90B10 50000h

Service life :

approx. 100000 hrs.

Light colour:

4000K neutral white (on demand 3000K or 5700K)

Luminous flux:

40700 Lm - comparable to a 600W sodium

high pressure lamp.

Built-in Philips driver.

Operating voltage:

202 - 254V 50 / 60Hz

Power consumption:

275 Watt

With short connecting cable and waterproof cable coupling

With pressure compensation valve

Permissible ambient temperature: - 40°C ... +50°C (against surcharge also -45°C ... +55°C)

Housing: die-cast aluminium, grey, with swivelling mounting bracket.

Wind load:

0.036m²

Protection class:

IP66

Impact resistance:

IK08

Dimensions:

Height 610, width 420, depth 80 mm

Weight: 8 kg

LED Floodlights and Spotlights Outdoor max. 50W



**Outdoor LED Flood Light 20W
3000K IP65**



Bright LED spotlight 20 Watt flat design, for advertising sign, house entrance, riding arena or public lighting.
LA-1560-023

The brightness is comparable to 200W halogen light.

Wide and uniformly bright beam 120°.

LED: Lumiled Power SMD
Service life: approx. 30000 hours
Light colour: 3000 K warm white
Luminous flux: 1700 Lm
Operating voltage: 100 - 240V 50 / 60Hz
Power consumption: 20 Watt
Housing: black aluminium,
with swivelling mounting bracket.
Protection class: IP65

Dimensions:

Width: 120 mm
Height: 95 mm
Depth: 25 mm
Weight: 0,85 kg



**Outdoor LED Flood Light 20W
4000K IP65**



Bright LED spotlight 20 Watt flat design, for advertising sign, house entrance, riding arena or public lighting.
LA-1560-033

The brightness is comparable to 200W halogen light.

Wide and uniformly bright beam 120°.

LED: Lumiled Power SMD
Service life: approx. 30000 hours
Light colour: 4000 K pure white
Luminous flux: 1700 Lm
Operating voltage: 100 - 240V 50 / 60Hz
Power consumption: 20 Watt
Housing: black aluminium,
with swivelling mounting bracket.
Protection class: IP65

Dimensions:

Width: 120 mm
Height: 95 mm
Depth: 25 mm
Weight: 0,85 kg



**Outdoor LED Flood Light 30W
IP65**



Bright LED spotlight 30 Watt flat design, 4000K for advertising sign, house entrance, riding arena or public lighting.
LA-1560-036

The brightness is comparable to 250W halogen light.

Wide and uniformly bright beam 120°.

LED: Lumiled Power SMD
Service life: approx. 30000 hours
Light colour: 4000 K pure white
Luminous flux: 2700 Lm
Operating voltage: 100 - 240V 50 / 60Hz
Power consumption: 30 Watt
Housing: black aluminium,
with swivelling mounting bracket.
Protection class: IP65



Dimensions:



Width: 160 mm
Height: 120 mm
Depth: 28 mm

Weight: 0,85 kg

	<p>Outdoor LED Flood Light 50W 4000K IP65</p>	<p>Bright LED floodlight 50 Watt flat design, for advertising sign, house entrance, riding arena or public lighting. Light intensity of 400 Watt halogen light. LA-1560-054</p>
		<p>Wide and uniformly bright beam 120°.</p> <p>LED: Lumiled Power SMD Service life: approx. 30000 hrs. Light colour: 4000 K natural white Luminous flux: 4500 Lm - comparable with 400W halogen light. Operating voltage: 100 - 240V 50 / 60Hz Power consumption: 50 Watt Housing: black aluminium, with swivelling mounting bracket. Protection class: IP65</p>
		<p>Dimensions: Width 284, height 232, depth 150 mm Weight: 0,85 kg</p>

Outdoor Flood Lights up to 150W

	<p>Outdoor LED Flood Light 100W 3000K IP65</p>	<p>Bright LED spotlight 100 Watt wide beam, for advertising sign, house entrance, riding arena or public lighting. Warm white light LA-1560-103</p>
		<p>The brightness is comparable to 800W halogen light.</p> <p>Wide and uniformly bright beam 120°.</p> <p>LED: Lumiled Power SMD Service life: approx. 30000 hours Light colour: 3000 K warm white Luminous flux: 8100 Lm Operating voltage: 100 - 240V 50 / 60Hz Power consumption: 100 Watt Housing: black aluminium, with swivelling mounting bracket. Protection class: IP65</p>
		<p>Dimensions: Width: 274 Height: 212 Depth: 40 mm Weight: 0,85 kg</p>

	<p>Outdoor LED Flood Light 100W 4000K IP65</p>	<p>Bright LED spotlight 100 Watt wide beam, for advertising sign, house entrance, riding arena or public lighting. Neutral white light LA-1560-104</p>
		<p>The brightness is comparable to 800W halogen light.</p> <p>Wide and uniformly bright beam 120°.</p> <p>LED: Lumiled Power SMD Service life: approx. 30000 hours Light colour: 4000 K natural white Luminous flux: 8200 Lm Operating voltage: 100 - 240V 50 / 60Hz Power consumption: 100 Watt Housing: aluminium black with swivelling mounting bracket. Protection class: IP65</p>
		<p>Dimensions: Width: 274 mm Height: 212 mm Depth: 40 mm Weight: 0,85 kg</p>

LED Outdoor Flood Lights 180W - 500W and Halogen



**Outdoor LED Flood Light 200W
IP65**

Bright LED floodlight 200 Watt flat design, for advertising sign, house entrance, riding arena or public lighting. Light intensity of 1600 Watt halogen light.
LA-1560-20

LED Floodlights and Spotlights Outdoor max. 50W



**Outdoor LED Flood Light
Slimline 30W IP65**



Bright LED spotlight 30 Watt, for advertising sign, house entrance or public lighting. Light intensity of 250 Watt halogen light.
LA-1563-3

Wide and uniformly bright beam 110°. With multi-LEDs for better efficiency and significantly longer life expectancy than the widely used 1-chip spotlights. Service life approx. 30000 hrs. Light colour: 4000K natural white (3000 K warm white on order) Luminous flux: 2700 Lm - comparable to a 250W incandescent lamp. Operating voltage: 220 - 240V 50 / 60Hz Power consumption 31 Watt Power factor: > 0,9 Housing: white aluminium (grey or black on request) with swivelling mounting bracket. Protection class IP65 Dimensions: Width 195, height 142, depth 30 mm Weight: 0,85 kg



**Outdoor LED Flood Light 30W
4000K IP65**

Powerful LED projector 30 watt
LA-1564-034

The brightness is comparable to 250W halogen light.

Wide and uniformly bright beam 120°. LED: Lumiled Power SMD Service life: approx. 30000 hrs. Light colour: 4000 K white Luminous flux: 2700 Lm Operating voltage: 100 - 240V 50 / 60Hz Power consumption: 30 Watt Housing: Aluminium grey, with swivelling mounting bracket. Protection class: IP65

Dimensions:
Width: 167 mm
Height: 122 mm
Depth: 28 mm

Weight: 0,85 kg



**Outdoor LED Flood Light 50W
4000K IP65**



Bright LED spotlight 50 Watt flat design
LA-1564-054

The brightness is comparable to 400W halogen light.

Wide and uniformly bright beam 120°.

LED: Lumiled Power SMD
Service life: approx. 30000 hours
Light colour: 4000 K white
Luminous flux: 4700 Lm
Operating voltage: 100 - 240V 50 / 60Hz
Power consumption: 50 Watt
Housing: Aluminium grey,
with swivelling mounting bracket.
Protection class: IP65

Dimensions:
Width: 213 mm
Height: 160 mm
Depth: 28 mm

Weight: 0,85 kg

Outdoor Flood Lights up to 150W



**Outdoor LED Flood Light 100W
4000K IP65**



Bright LED spotlight 100 Watt flat design
LA-1564-104

The brightness is comparable to 800W halogen light.

Wide and uniformly bright beam 120°.

LED: Lumiled Power SMD
Service life: approx. 30000 hours
Light colour: 4000 K white
Luminous flux: 8000 Lm
Operating voltage: 100 - 240V 50 / 60Hz
Power consumption: 100 Watt
Housing: Aluminium grey,
with swivelling mounting bracket.
Protection class: IP65

Dimensions:
Width: 277 mm
Height: 210 mm
Depth: 30 mm

Weight: 0,85 kg

LED Outdoor Flood Lights 180W - 500W and Halogen



**Outdoor LED Flood Light 200W
4000K IP65**

Bright LED spotlight 200 Watt flat design
LA-1564-204

The brightness is comparable to 1600W halogen light.

Wide and uniformly bright beam 120°.

LED: Lumiled Power SMD
Service life: approx. 30000 hours
Light colour: 4000 K white
Luminous flux: 18000 Lm
Operating voltage: 100 - 240V 50 / 60Hz
Power consumption: 200 Watt
Housing: Aluminium grey,
with swivelling mounting bracket.
Protection class: IP65

Dimensions:
Width: 393 mm
Height: 280 mm
Depth: 50 mm

Weight: 0,85 kg

LED Floodlights and Spotlights Outdoor max. 50W



Outdoor LED Lens Floodlight 30W (250W) IP65



Focused light for yard, garden, industrial or public lighting. Bright LED spotlight 30 Watt with glass lens.
The light intensity is comparable to 300 Watt halogen light.
LA-1573

Ideal for construction, yard, parking, etc.
Save energy, maintenance costs and provide better illumination.
With generously dimensioned heat sinks for better heat distribution and long life expectancy.
Large optical lenses for bright and uniform light emission, even at higher distances.
Brightness similar to 250 watt halogen or 70W metal halide lamp.
Aprx. life time: 50000 hours.
Included PWM LED driver.
Housing: die-cast aluminum, dark gray powder coated.
Cover: clear tempered glass, flat 4mm.
Adjustable mounting bracket: 160 degrees
Recommended mounting height: 3m - 5m

Optical properties:
LED: Epistar Power LEDs
Lumens: 3050 Lm
Light color: 4000K natural white
Colour index: CRI > 80
Light distribution: 60° or 100°

Operating voltage: 220V - 240V (on request also for 12V-24V battery voltage.)
Frequency: 50 / 60Hz
Power consumption: 35W
Power factor: > 0.9
Large ambient temperature range: -20°C to + 50°C
Protection degree: IP65, splashproof.
Impact resistance: IK10
Dimensions: Width 215, height 178, depth 81 mm
Weight: 1,75 kg



Outdoor Lens LED Floodlight 50W IP65



Focused light for industrial or public lighting. Very bright LED spotlight 50 Watt with glass lens.
The light intensity is comparable to 500 Watt halogen light.
LA-1574

Ideal for construction, yard, parking, etc.
Save energy, maintenance costs and provide better illumination.
With generously dimensioned heat sinks for better heat distribution and long life expectancy.
Large optical lenses for bright and uniform light emission, even at higher distances.
Brightness similar to 400 watt halogen or 100W metal halide lamp.
Aprx. life time: 50000 hours.
Included PWM LED driver.
Housing: die-cast aluminum, dark gray powder coated.
Cover: clear tempered glass, flat 4mm.
Adjustable mounting bracket: 160 degrees
Recommended mounting height: 3m - 6m

Optical properties:
LED: Epistar Power LEDs
Lumens: 5100 Lm
Light color: 4000K natural white
Colour index: CRI > 80
Light distribution: 60° or 100°

Operating voltage: 220V - 240V (on request also for 12V-24V battery voltage.)
Frequency: 50 / 60Hz
Power consumption: 55W
Power factor: > 0.9
Large ambient temperature range: -20°C to + 50°C
Protection degree: IP65, splashproof.
Impact resistance: IK10
Dimensions: Width 253, height 194, depth 95 mm
Weight: 2,25 kg

Outdoor Flood Lights up to 150W



Outdoor Lens LED Floodlight 70W IP65



Focused light for industrial or public lighting. Bright LED spotlight 70 Watt with glass lens.
The light intensity is comparable to 600 Watt halogen light.
LA-1575

Ideal for construction, yard, parking, etc.
Save energy, maintenance costs and provide better illumination.
With generously dimensioned heat sinks for better heat distribution and long life expectancy.
Large optical lenses for bright and uniform light emission, even at higher distances.
Brightness similar to 600 watt halogen or 150W metal halide lamp
Aprx. life time: 50000 hours.
Included PWM LED driver.
Housing: die-cast aluminum, dark gray powder coated.
Cover: clear tempered glass, flat 4mm.
Adjustable mounting bracket: 160 degrees
Recommended mounting height: 4m - 7m

Optical properties:
LED: Epistar Power LEDs
Lumens: 7100 Lm
Light color: 4000K natural white
Colour index: CRI > 80
Light distribution: 60° or 100°

Operating voltage: 220V - 240V (on request also for 12V-24V battery voltage.)
Frequency: 50 / 60Hz
Power consumption: 75W
Power factor: > 0.9
Large ambient temperature range: -20°C to + 50°C
Protection degree: IP65, splashproof.
Impact resistance: IK10
Dimensions: Width 260, height 200, depth 100 mm
Weight: 2,55 kg



Outdoor LED Floodlight 150W Fisheye lenses IP65



Focused light for industrial or public lighting. Very bright LED spotlight 150 Watt with glass lens.
The light intensity is equivalent to 1200 Watt halogen light.
LA-1577

Ideal for construction, yard, parking, etc.
Save energy, maintenance costs and provide better illumination.
With generously dimensioned heat sinks for better heat distribution and long life expectancy.
Large optical lenses for bright and uniform light emission, even at higher distances.
Brightness similar to 1200 watt halogen or 250W metal halide lamp.

Aprx. life time: 50000 hours.
Included PWM LED driver.
Housing: die-cast aluminum, dark gray powder coated.
Cover: clear tempered glass, flat 4mm.
Adjustable mounting bracket: 160 degrees
Recommended mounting height: 5m - 10m

Optical properties:
LED: Epistar Power LEDs
Lumens: 14200 Lm
Light color: 4000K natural white
Colour index: CRI > 80
Light distribution: 90° or 120°

Operating voltage: 220V - 240V (on request also for 12V-24V battery voltage.)
Frequency: 50 / 60Hz
Power consumption: 150W
Power factor: > 0.9
Large ambient temperature range: -20°C to + 50°C
Protection degree: IP65, splashproof.
Impact resistance: IK10
Dimensions: width 440, height 240, depth 155 mm
Weight: 5,7 kg



Outdoor Lens LED Floodlight 150W IP65



Focused light for industrial or public lighting. Very bright LED spotlight 150 Watt with glass lenses.
The luminous intensity is equivalent to 1400 Watt halogen light.
LA-1578

Ideal for construction, yard, parking, etc.
Save energy, maintenance costs and provide better illumination.
With generously dimensioned heat sinks for better heat distribution and long life expectancy.

Large optical lenses for bright and uniform light emission, even at higher distances.

Brightness similar to a 300W metal halide high-pressure lamp.

Aprx. life time: 50000 hours.

Included PWM LED driver.

Housing: die-cast aluminum, dark gray powder coated.

Cover: clear tempered glass, flat 4mm.

Adjustable mounting bracket: 160 degrees

Recommended mounting height: 5m - 10m

Optical properties:

LED: Epistar Power LEDs

Lumens: 14900 Lm

Light color: 4000K natural white

Colour index: CRI > 80

Light distribution: 90° or 120°

Operating voltage: 85V - 265V (on request also for 12V-24V battery voltage.)

Frequency: 50 / 60Hz

Power consumption: 160W

Power factor: > 0.9

Large ambient temperature range: -20°C to + 50°C

Protection degree: IP65, splashproof.

Impact resistance: IK10

Dimensions: width 440, height 240, depth 155 mm

Weight: 5,7 kg

Narrow Beam Spotlights Outdoor



Outdoor LED Floodlight Spot 8° 15° 30° 45° 36W IP65



Bright LED spotlight 36 Watt, narrow beam, for targeted illumination.
Light intensity comparable to 350 Watt halogen light.
LA-1582

With power LEDs and lens optics for directional light.
Built-in PWM driver.

Directional beam: 15° (from 10 pieces also available with 8°, 30° or 45°).

Light colour: 4000 K neutral white.

Luminous flux: 3300 Lm - comparable to a 350W incandescent lamp.

Service life: approx. 50000 hrs.

Operating voltage: 85V - 240V 50 / 60Hz

Power consumption: 37W

LED power: 36W

Housing: die-cast aluminium, grey, with swivelling mounting bracket.

Protection class: IP65

Dimensions: Diameter 230mm, height 245mm

Weight: 0,85 kg

LED Outdoor Flood Lights 180W - 500W and Halogen



LED Floodlight Antares 175W



Very bright LED floodlight Mast luminaire from European production. Symmetrical or asymmetrical radiation 23790 Lm LA-1586-2

Ideal for area lighting, sports field, construction site, car parks, etc. Flicker-free - also for filming. Save energy, maintenance costs and achieve better illumination. The light intensity is comparable to 2000 Watt halogen. Quality - made in Europe

Recommended light point height: 6m - 10m

Optical properties:
 LEDs: Samsung LH181B
 LED luminous flux Lumen: 26000 Lm
 Luminaire luminous flux: 23790 Lm
 Pleasant colour temperature: 4000K neutral white (from 20 pieces also available in 2200K yellow, 3000K warm white, 5700K daylight)
 Colour rendering: Ra > 80
 Luminous flux constancy: 80,000h L80 B10 @ ta25, 50,000h L80 B20 @tamax.
 Ambient temperature ta: -35° to +45°C

Available in different beam characteristics:
 Symmetrical: 120° very wide,
 asymmetrical: max. 50° deflection for wide-area illumination

Technical data:
 Operating voltage: 220V-240V, 50Hz-60Hz
 Power consumption 175W
 Surge protection: 10 KV
 Protection class IP66, splash-proof
 Impact resistance: IK10
 Certifications: CE, ENEC

On request we supply with dimmable driver:
 DALI or autom. midnight dimming

Housing:
 Material: die-cast aluminium, grey powder-coated
 Swivelling bracket: 180 degrees
 Cover: Clear tempered glass, flat 4mm.
 Wind load: 0.265m²
 Dimensions: L 510 mm, W 524mm, H 97 mm

Dialux files:
 Weight: 20,52 kg



LED Floodlight Antares 245W

Very bright LED floodlight Mast luminaire from European production. Symmetrical or asymmetrical radiation 33310 Lm LA-1586-4



LED Floodlight Antares 280W

Very bright LED floodlight for sports field or car park from European production. Symmetrical or asymmetrical radiation 38070 Lm LA-1586-5



LED Floodlight Antares 315W

Very bright LED floodlight 42825 Lm, for sports field or car park from European production. Symmetrical or asymmetrical radiation LA-1586-8



**LED Stadium Flood Light MAC
480W**



Very bright floodlight and spotlight for large car parks, construction site, airport or football pitch. 73,900 lm
Manufactured in the EU. The individual levels can be swivelled. Energy-saving.
LA-1587-4

Very bright luminary for adjustable mount on high poles or canopy.
Very equal lighting on wide fields.
With Meanwell LED driver and power stabilization for constant brightness, even at voltage fluctuations.
Low power consumption, no maintenance costs, very long service life.
Ready to install, including LED lamps.
By the high number of power LED, there results a better heat dissipation in the fixture and an extended life time.

LED Quantity:	192 pcs
Lamp Luminous Flux:	76,800 lm
Light distribution:	Asymmetric 55° or 20°, 30° or 45°
Color temperature:	4000K (pure white)
Color Rendering Index:	CRI > 80
Lamp Efficiency:	160 lm/W
Dimmable:	On request available with 1-10V, DALI or DMX dimming
Input Voltage:	AC 90 - 305V
Frequency Range:	50 - 60Hz
Power Factor:	0.95
Ambient temperature during operation:	-20 Deg C ... +55 Deg C
LED power:	480W
Life time:	126,000h
Total power consumption:	500W
Ambient humidity:	10% - 90%

Very rigid aluminium die-cast casing with black finishing and adjustable mounting bracket.
GORE® Protective Vents system
Protection grade: IP66 for outdoor and dustproof
Shockproof: IK05
Approvals: TÜV, ENEC, CE
Dimensions: W 600mm * H 560mm * D 75mm, including mounting bracket 370mm
Weight: 18 kg

Stadium Lights and LED Floodlights 600W - 2000W



**LED Stadium Flood Light MAC
720W**



Very bright floodlight and spotlight for large car parks, construction site, airport or football pitch. 104,088 lm
Manufactured in the EU. The individual levels can be swivelled. **Energy-saving.**
LA-1587-6

Very bright luminary for adjustable mount on high poles or canopy.
Very equal lighting on wide fields.
With Meanwell LED driver and power stabilization for constant brightness, even at voltage fluctuations.
Low power consumption, no maintenance costs, very long service life.
Ready to install, including LED lamps.
By the high number of power LED, there results a better heat dissipation in the fixture and an extended life time.

LED Quantity:	288 pcs
Lamp Luminous Flux:	104,088 lm
Light distribution:	Asymmetric 55° or 20°, 30° or 45°
Color temperature:	4000K (pure white)
Color Rendering Index:	CRI > 80
Lamp Efficiency:	160 lm/W
Dimmable:	On request available with 1-10V, DALI or DMX dimming
Input Voltage:	AC 90 - 305V
Frequency Range:	50 - 60Hz
Power Factor:	0.95
Ambient temperature during operation:	-20 Deg C ... +55 Deg C
LED power:	720W
Life time:	126,000h
Total power consumption:	740W
Ambient humidity:	10% - 90%
Very rigid aluminium die-cast casing with black finishing and adjustable mounting bracket.	
GORE® Protective Vents system	
Protection grade:	IP66 for outdoor and dustproof
Shockproof:	IK05
Approvals:	TÜV, ENEC, CE
Dimensions:	W 640mm * H 830mm * D 75mm, including mounting bracket 370mm
Weight:	35 kg



**LED Stadium Flood Light MAC
1000W**



Very bright floodlight and spotlight for large car parks, construction sites, airports or football grounds. 147,800 lm
Manufactured in the EU. The individual levels can be swivelled. Energy-saving.
LA-1587-8

Very bright luminary for adjustable mount on high poles or canopy.
Very equal lighting on wide fields.
With Meanwell LED driver and power stabilization for constant brightness, even at voltage fluctuations.
Low power consumption, no maintenance costs, very long service life.
Ready to install, including LED lamps.
By the high number of power LED, there results a better heat dissipation in the fixture and an extended life time.

LED Quantity:	384 pcs
Lamp Luminous Flux:	147,800 lm
Light distribution:	Asymmetric 55° or 20°, 30° or 45°
Color temperature:	4000K (pure white)
Color Rendering Index:	CRI > 80
Lamp Efficiency:	160 lm/W
Dimmable:	On request available with 1-10V, DALI or DMX dimming
Input Voltage:	AC 90 - 305V
Frequency Range:	50 - 60Hz
Power Factor:	0.95
Ambient temperature during operation:	-20 Deg C ... +55 Deg C
LED power:	960W
Life time:	126,000h
Total power consumption:	1000W
Ambient humidity:	10% - 90%
Very rigid aluminium die-cast casing with black finishing and adjustable mounting bracket.	
GORE® Protective Vents system	
Protection grade:	IP66 for outdoor and dustproof
Shockproof:	IK05
Approvals:	TÜV, ENEC, CE
Dimensions:	W 640mm * H 1110mm * D 75mm, including mounting bracket 370mm
Weight:	44 kg



LED Flood Light 1000W Airport Apron Lighting



Very bright floodlight and spotlight for large car parks, construction site, airport or football pitch. Energy-saving.
LA-1591

Very bright luminary for adjustable mount on high poles or canopy.
Light distribution: Asymmetric 130 deg * 80 deg, or symmetrical 80°, 100° or 120°

Very equal lighting on wide fields.

With Meanwell LED driver and power stabilization for constant brightness, even at voltage fluctuations.

Low power consumption, no maintenance costs, very long service life.

Ready to install, including LED lamps.

By the high number of power LED, there results a better heat dissipation in the fixture and an extended life time.

LED: SMD 5050

Lamp Luminous Flux: 126,000 lm

Average Illuminance (with 85° x 135° lens)

at 6 meters: 650 lux (10.9x28.9 meters)

at 8 meters: 363 lux (14.6x38.6 meters)

at 10 meters: 305 lux (18.2x46.5 meters)

Color Rendering Index: CRI > 70

Lamp Efficiency: 130 lm/W

Input Voltage: AC 100 - 295V

Frequency Range: 50 - 60Hz

Power Factor 0.9

Ambient temperature: -25 Deg C ... +50 Deg C

LED power: 1000W

Life time 50000h

Total power consumption: 1020W

Ambient humidity: 10% - 90%

Color temperature: 5000K (daylight), on order available with 4000K or 6000K

Very rigid aluminium die-cast casing with black finishing and adjustable mounting bracket.

Protection grade IP65 for outdoor and dustproof

Dimensions: W 611mm * H 426mm * D 117mm, including mounting bracket 370mm

Weight: 24 kg

LED Outdoor Flood Lights 180W - 500W and Halogen



LED floodlight and tennis court lighting 240W



GEO-Technik
LA-1593-2

Bright floodlight and spotlight 38,400 lm, for car park, construction site, tennis court or basketball court. Energy-saving.
LA-1593-2

Very bright luminary for adjustable mount on high poles or canopy. Very equal lighting on wide fields. With Meanwell LED driver and power stabilization for constant brightness, even at voltage fluctuations. Low power consumption, no maintenance costs, very long service life. Ready to install, including LED lamps. By the high number of power LED, there results a better heat dissipation in the fixture and an extended life time. By the hexagon design of the cooling profiles, the wind load is reduced and the cooling of the LED modules is excellent.

- LED Quantity: 120 pcs
- Lamp Luminous Flux: 38,400 lm
- Light distribution: 20°, 30° or 45°
- Color temperature: 5000K (daylight), on order available with 3000K, 4000K or 6000K
- Color Rendering Index: CRI > 80
- Lamp Efficiency: 160 lm/W
- Dimmable: On request available with 1-10V, DALI or DMX dimming
- Input Voltage: AC 100 - 277V
- Frequency Range: 50 - 60Hz
- Power Factor: 0.95
- Ambient temperature during operation: -20 Deg C ... +55 Deg C
- LED power: 240W
- Life time: 100,000h
- Total power consumption: 250W
- Ambient humidity: 10% - 90%
- Very rigid aluminium die-cast casing with black finishing and adjustable mounting bracket.
- Protection grade: IP67 for outdoor and dustproof
- Shockproof: IK10
- Dimensions: W 507mm * H 301mm * D 75mm, including mounting bracket 370mm
- Weight: 16 kg



LED Stadium Flood Light 480W



LA-1593-4

Very bright floodlight and spotlight 76,800 lm, for large car parks, construction site, airport or football pitch. Energy-saving.
LA-1593-4

Very bright luminary for adjustable mount on high poles or canopy.
Very equal lighting on wide fields.
With Meanwell LED driver and power stabilization for constant brightness, even at voltage fluctuations.
Low power consumption, no maintenance costs, very long service life.
Ready to install, including LED lamps.
By the high number of power LED, there results a better heat dissipation in the fixture and an extended life time.
By the hexagon design of the cooling profiles, the wind load is reduced and the cooling of the LED modules is excellent.

LED Quantity:	240 pcs
Lamp Luminous Flux:	76,800 lm
Light distribution:	20°, 30° or 45°
Color temperature:	5000K (daylight), on order available with 3000K, 4000K or 6000K
Color Rendering Index:	CRI > 80
Lamp Efficiency:	160 lm/W
Dimmable:	On request available with 1-10V, DALI or DMX dimming
Input Voltage:	AC 100 - 277V
Frequency Range:	50 - 60Hz
Power Factor:	0.95
Ambient temperature during operation:	-20 Deg C ... +55 Deg C
LED power:	480W
Life time:	100,000h
Total power consumption:	500W
Ambient humidity:	10% - 90%
Very rigid aluminium die-cast casing with black finishing and adjustable mounting bracket.	
Protection grade:	IP67 for outdoor and dustproof
Shockproof:	IK10
Dimensions:	W 460mm * H 460mm * D 75mm, including mounting bracket 370mm
Weight:	20 kg

Stadium Lights and LED Floodlights 600W - 2000W



LED Stadium Flood Light 720W

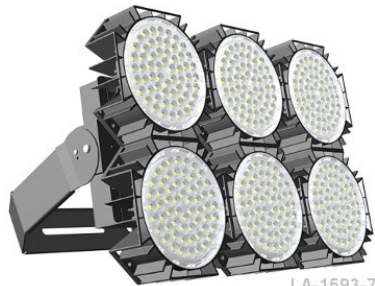

LA-1593-7

Very bright floodlight and spotlight 115,200 lm, for large car parks, construction site, airport or football pitch. Energy-saving. LA-1593-7

Very bright luminary for adjustable mount on high poles or canopy. Very equal lighting on wide fields. With Meanwell LED driver and power stabilization for constant brightness, even at voltage fluctuations. Low power consumption, no maintenance costs, very long service life. Ready to install, including LED lamps. By the high number of power LED, there results a better heat dissipation in the fixture and an extended life time. By the hexagon design of the cooling profiles, the wind load is reduced and the cooling of the LED modules is excellent.

LED Quantity:	360 pcs
Lamp Luminous Flux:	115,200 lm
Light distribution:	20°, 30° or 45°
Color temperature:	5000K (daylight), on order available with 3000K, 4000K or 6000K
Color Rendering Index:	CRI > 80
Lamp Efficiency:	160 lm/W
Dimmable:	On request available with 1-10V, DALI or DMX dimming
Input Voltage:	AC 100 - 277V
Frequency Range:	50 - 60Hz
Power Factor:	0.95
Ambient temperature during operation:	-20 Deg C ... +55 Deg C
LED power:	720W
Life time:	100,000h
Total power consumption:	740W
Ambient humidity:	10% - 90%
Very rigid aluminium die-cast casing with black finishing and adjustable mounting bracket.	
Protection grade:	IP67 for outdoor and dustproof
Shockproof:	IK10
Dimensions:	W 690mm * H 460mm * D 75mm, including mounting bracket 370mm
Weight:	25 kg



LED Stadium Flood Light 1000W

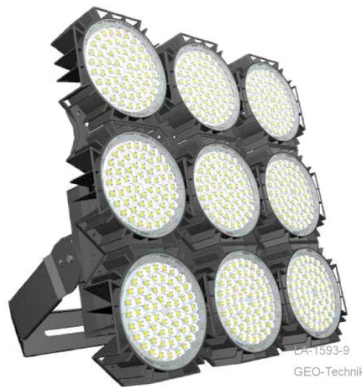

LA-1593-9
GEO-Technik

Very bright power floodlight LED 1000 watt. Energy saving, for large building site, football places, parking lots or airfield lighting.
LA-1593-8

Very bright luminary for adjustable mount on high poles or canopy. Very equal lighting on wide fields. With Meanwell LED driver and power stabilization for constant brightness, even at voltage fluctuations. Low power consumption, no maintenance costs, very long service life. Ready to install, including LED lamps. By the high number of power LED, there results a better heat dissipation in the fixture and an extended life time. By the hexagon design of the cooling profiles, the wind load is reduced and the cooling of the LED modules is excellent.

- LED Quantity: 540 pcs
- Lamp Luminous Flux: 153,600 lm
- Light distribution: 20°, 30° or 45°
- Color temperature: 5000K (daylight), on order available with 3000K, 4000K or 6000K
- Color Rendering Index: CRI > 80
- Lamp Efficiency: 160 lm/W
- Dimmable: On request available with 1-10V, DALI or DMX dimming
- Input Voltage: AC 100 - 277V
- Frequency Range: 50 - 60Hz
- Power Factor: 0.95
- Ambient temperature during operation: -20 Deg C ... +55 Deg C
- LED power: 960W
- Life time: 100,000h
- Total power consumption: 1000W
- Ambient humidity: 10% - 90%
- Very rigid aluminium die-cast casing with black finishing and adjustable mounting bracket.
- Protection grade: IP67 for outdoor and dustproof
- Shockproof: IK10
- Dimensions: W 690mm * H 690mm * D 75mm, including mounting bracket 370mm
- Weight: 35 kg



LED Flood Light Flexible 1300W



Very bright power floodlight LED 1300 watt. 208000 lumens, energy saving, for large building site, football places, parking lots or airfield lighting.
LA-1593-9

Very bright luminary for adjustable mount on high poles or canopy.
Very equal lighting on wide fields.
With Meanwell LED driver and power stabilization for constant brightness, even at voltage fluctuations.
Low power consumption, no maintenance costs, very long service life.
Ready to install, including LED lamps.
By the high number of power LED, there results a better heat dissipation in the fixture and an extended life time.
By the hexagon design of the cooling profiles, the wind load is reduced and the cooling of the LED modules is excellent.

LED Quantity:	540 pcs
Lamp Luminous Flux:	199,680 lm
Light distribution:	20°, 30° or 45°
Color temperature:	5000K (daylight), on order available with 3000K, 4000K or 6000K
Color Rendering Index:	CRI > 80
Lamp Efficiency:	160 lm/W
Dimmable:	On request available with 1-10V, DALI or DMX dimming
Input Voltage:	AC 100 - 277V
Frequency Range:	50 - 60Hz
Power Factor:	0.95
Ambient temperature during operation:	-20 Deg C ... +55 Deg C
Life time:	160,000h
Total power consumption:	1300W
Ambient humidity:	10% - 90%
Very rigid aluminium die-cast casing with black finishing and adjustable mounting bracket.	
Protection grade:	IP67 for outdoor and dustproof
Shockproof:	IK10
Dimensions::	W 690mm * H 920mm * D 75mm, including mounting bracket 370mm
Weight:	45,5 kg



LED Flood Light 650W Stadium Lighting



Bright and energy saving power floodlight LED 650 watt. For large building site, parking places or airfield lighting.
LA-1596

Very bright luminary for adjustable mount on high masts.
Light distribution: Symmetric 60° or 120°
Very equal lighting on wide fields.
With LED driver and power stabilization for constant brightness, even at voltage fluctuations.
Low power consumption, no maintenance costs, very long service life.
Including LED lamps Bridgelux.
Each power LED has a circular heat sink for a better heat dissipation in the fixture and an extended life time.

LED Quantity:	8 pcs
Color temperature:	4000K pure white, on order available with 5000K (daylight), or 6000K (cold white)
Lamp Luminous Flux:	69000 lm
Color Rendering Index:	CRI > 75
LED efficiency:	120 lm/W
Lamp efficiency:	105 lm/W
Input Voltage:	AC 100 - 295V
Frequency Range:	50 - 60Hz
Power Factor:	0.95
Ambient temperature during operation:	-40C deg ... +50 C deg
LED power:	600W
Life time:	50000h
Total power consumption:	650W
Ambient humidity:	10% - 90%
Very rigid casing of steel and aluminium, with grey finishing and adjustable mounting bracket.	
Protection grade:	IP65 for outdoor and dustproof
Dimensions:	W 810mm * h 430mm * d 180mm, including mounting bracket 370mm
Weight:	38 kg

Outdoor Flood Lights up to 150W



LED Lighting for Dog Training Field



Lighting set with 2 poles for horse riding ground or small sport court. (18m x 22m)
LA-1701

With this set, you can ideally illuminate your training ground, riding arena or dog training area.
Particularly in the dark season, this small floodlight system makes it possible to use the different of the different areas is possible.
Bright and even - yet energy-saving - no need to change lamps.
If your arena is located outside and there is no electricity connection available, we also offer solar riding arena lighting.
We deliver with poles (or on request without lampposts) if old telephone poles are available.
The light is bright immediately after switching on - no waiting time.
The LED spotlights have a large reflector for uniform, wide light distribution.
The brightness is comparable with two 1000 Watt halogen spotlights.

Light beam: 120° very wide
LED service life: approx. 50000 hours
Light colour: 4000 K neutral white
Luminous flux: 2 x 10100 Lm
Ambient temperature range: -20°C to + 45°C
Operating voltage: 230V 50 / 60Hz
Total power consumption: 210 Watt

- Complete set:
- 2 light poles 5m galvanised steel
 - 2 LED floodlights 100W
 - 2 mast brackets for floodlights
 - 2 junction boxes
 - 10m mast connection cable
 - 34m underground cable

Weight: 100 kg

LED Outdoor Flood Lights 180W - 500W and Halogen



Lighting Package for Horse Riding Field with 4 Posts

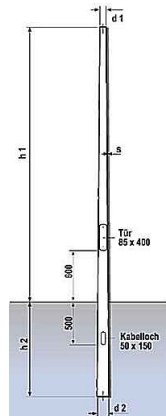

LED floodlights with 4 steel poles 6 meters for lighting riding arenas. (up to 30m x 40m)
LA-1702

With this set, you can ideally illuminate your practice area, riding arena or sports field.
Especially in the dark season, this riding arena lighting allows for an effective use of the various terrains.
of the different areas is possible.
Very bright and uniform - yet energy-saving - No lamp change required.
A good choice for riding clubs or riding arenas.
If your arena is located outside and no electricity is available, we also offer solar riding arena lighting.
We deliver with poles (or on request without lampposts) if old telephone poles are available.
The light is bright immediately after switching on - no waiting time.
The LED spotlights have a large reflector for uniform, wide light distribution.
The brightness is comparable with four 1500 W halogen spotlights or 4 x 250 W high-pressure metal halide lamps.

Light emission: 120° very wide
LED service life: approx. 50000 hours
Light colour: 4000 K neutral white
Luminous flux: 4 x 18000 Lm
Ambient temperature range: -20°C to + 45°C
Operating voltage: 230V 50 / 60Hz
Total power consumption: 600 Watt

- Complete set:
- 4 light poles 6m galvanised steel
 - 4 LED floodlights
 - 4 mast brackets for floodlights
 - 4 junction boxes
 - 10m mast connection cable
 - 110m underground cable
- Weight: 158 kg

Outdoor Flood Lights up to 150W



LED Lighting for Horse Riding Field



LED floodlight for inexpensive riding arena lighting and for small sports fields. (20m x 40m)
LA-1706

With this set, you can ideally illuminate your training ground, riding arena or sports field. Especially in the dark season, this riding arena lighting allows for an effective use of the various terrains. of the different areas is possible. Bright and uniform - yet energy-saving - No lamp change required. A good choice for riding clubs or riding arenas. If your grounds are outside and there is no electricity connection, we also offer solar riding arena lighting. The LED spotlights can be mounted on existing poles (you can also order poles of any length). The light is bright immediately after switching on - no waiting time. The LED spotlights have a large reflector for uniform, wide light distribution. The brightness is comparable to four 1000 Watt halogen spotlights.

Light beam: 120° very wide
LED service life: approx. 50000 hours
Light colour: 4000 K neutral white
Luminous flux: 4 x 10100 Lm
Ambient temperature range: -20°C to + 45°C
Operating voltage: 230V 50 / 60Hz
Total power consumption: 420 Watt

Complete set:
- 4 LED floodlights 100W
- 20m connection cable
- 80m underground cable
- 4 cable connections
Weight: 24 kg



LED Lighting for Horse Riding Field with 4 Posts



Lighting set with 4 poles for horse riding ground or smaller sport court. (20m x 40m)
LA-1707

With this set, you can ideally illuminate your training ground, riding arena or sports field. Especially in the dark season, this riding arena lighting allows for an effective use of the various terrains. of the different areas is possible. Bright and uniform - yet energy-saving - No lamp change required. A good choice for riding clubs or riding arenas. If your arena is located outside and no electricity is available, we also offer solar riding arena lighting. We deliver with poles (or on request without lampposts) if old telephone poles are available.

The light is bright immediately after switching on - no waiting time. The LED spotlights have a large reflector for uniform, wide light distribution. The brightness is comparable to four 1000 Watt halogen spotlights.

Light beam: 120° very wide
LED service life: approx. 50000 hours
Light colour: 4000 K neutral white
Luminous flux: 4 x 10100 Lm
Ambient temperature range: -20°C to + 45°C
Operating voltage: 230V 50 / 60Hz
Total power consumption: 420 Watt

Complete set:
- 4 light poles 5m steel galvanised
- 4 LED floodlights 100W, incl. connection cable
- 4 pole brackets for floodlights
- 4 junction boxes with fuse
- 92m underground cable
Weight: 148 kg

LED Outdoor Flood Lights 180W - 500W and Halogen



Lighting Package for Riding Field with high masts

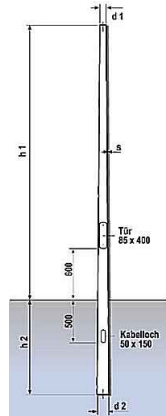

Lighting set with 4 poles 7 meters high for horse riding ring or smaller sports ground. (40m x 40m)
LA-1708

With this set, you can ideally illuminate your training ground, riding arena or sports field.
Especially in the dark season, this riding arena lighting allows for an effective use of the various terrains.
of the different areas is possible.
Very bright and uniform - yet energy-saving - No lamp change required.
A good choice for riding clubs or riding arenas.
If your arena is located outside and there is no electricity connection available, we also offer solar riding arena lighting.
The light is bright immediately after switching on - no waiting time.
The LED spotlights have a large reflector for even, wide light distribution.
The brightness is comparable to four 2000 Watt halogen spotlights or 4 x 250W metal halide high-pressure lamps.

Light emission: 120° very wide
LED service life: approx. 50000 hours
Light colour: 4000 K neutral white
Luminous flux: 4 x 20000 Lm
Ambient temperature range: -20°C to + 45°C
Operating voltage: 230V 50 / 60Hz
Total power consumption: 800 Watt

- Complete set:
- 4 light poles 5m + 2m galvanised steel
 - 4 LED floodlights 200W
 - 4 mast brackets for floodlights
 - 4 junction boxes
 - 10m mast connection cable
 - 110m underground cable
- Weight: 158 kg

Outdoor Flood Lights up to 150W



Outdoor LED Floodlight for Hi Speed Cam 70W IP65



Very bright LED floodlight for industrial purposes, floodlight for high-speed camera, crash test and film indoors and outdoors IP66.
The light intensity corresponds to about 500 watts of halogen light.
LA-1719

Uniform, very bright beam 60°. With large lens and generously dimensioned heat sink for excellent light emission and long life expectancy. Significantly brighter than a 70W metal halide high-pressure lamp.

Lifetime approx. 50000 hrs.
Built-in PWM driver - flicker-free and hum-free
Housing: Die-cast aluminium, dark grey powder-coated.
Cover: Clear tempered glass, flat 4mm.
Pivoting bracket: 160 degrees
Recommended light range: 2m - 7m

Optical properties:
LED: Epistar Power LEDs
Lumen luminous flux: 7100 Lm
Light colour: 4000K neutral white
Colour rendering index: Ra > 80
Light distribution: 60

Operating voltage: 220V - 240V (from 10 pcs. also available for 12V - 24V DC)
Frequency: 50 / 60Hz
Flicker: < 1%
Power consumption: 75W
Power factor: > 0,9
Ambient temperature range: -20°C to + 50°C
Protection class: IP65, splash-proof.
Impact resistance: IK10
Dimensions: Width 260, height 200, depth 100 mm
Weight: 4,7 kg



Outdoor LED Floodlight for Hi Speed Cam 136W IP65



Very bright LED floodlight for industrial purposes, floodlight for high-speed camera, crash test and film indoors and outdoors IP66.
The light intensity corresponds to about 1500 Watt halogen light.
LA-1725

Uniform, very bright beam 60°. With Power LED Osram

Luminous flux reduction: L90B10 50000h
Service life: approx. 100000 hrs.
Light colour: 4000K neutral white (from 10 pcs. also 3000K or 5700K)
Colour rendering: Ra > 70
Luminous flux: 18800 Lm - comparable to a 250W metal halide high pressure lamp.
Driver: Philips Xitanium, PWM driver - flicker-free and hum-free
Operating voltage: 202 - 254V 50 / 60Hz
Overvoltage protection: 4 kV (6kV)
Power consumption: 136 Watt
Power factor: 0.98
Flicker: < 4%

With short connecting cable and waterproof cable coupling
With pressure compensation valve
Permissible ambient temperature: - 20°C ... +50°C (also -45°C ... +55°C at extra charge)
Housing: die-cast aluminium, grey, with swivelling mounting bracket.
Wind load: 0.028m²
Protection class: IP66
Impact resistance: IK08
Dimensions: Height 442, width 347, depth 64 mm
Weight: 4,7 kg



LED Floodlight for Ski Run 150W



Very bright LED floodlight 150 Watt, for ski slopes and downhill runs. Attachment to floodlight poles or to the ski lift poles.
LA-1730

Wide and bright light distribution 120°
LED flood lighting has great advantages: Energy economizing (50 - 90%), more safety (the light is immediately bright) and maintenance free (no yearly lamps replacement).
With big glass lenses and large dimension thermal module for excellent light output and long life expectancy.
Very few blinding to the sides or into the sky.
We recommend, to install always 2 floodlights on each pole. Showing upwards the hill and downwards, to get a more equal lighting of the ski run.

Lifetime 50000h
Light colour 4000K natural white.
Light intensity 14900 Lm - similar to 1500 watt halogen or 300W metal halide lamp.
Included PWM LED driver.
Large ambient temperature range: -20°C to + 50°C
Operating voltage: 230V 50 / 60Hz (on request for 12V-24V battery voltage.)
Power consumption: 160 Watt
Housing: Aluminium die-cast black, with adjustable mounting bracket.
Protection degree IP65.
Dimensions: Width 440, height 240, depth 155 mm
Weight: 5,7 kg

LED Outdoor Flood Lights 180W - 500W and Halogen



LED Floodlight for Ski Run 220W

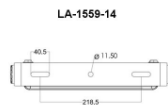

Very powerful LED projector 220 watt for Skirun Lighting. Installation on highmasts or on the existing masts of the ski lift.
LA-1730-2

Wide and uniformly bright light beam 120° with asymmetrical lens optics. The LED floodlight has the advantage of energy savings (50 - 90%), increased safety (the light is immediately bright) and freedom from maintenance (no annual lamp replacement).
Robust housing with large cooling body for excellent light distribution and long life expectancy.
Low glare to the side and into the sky.
We recommend always mounting 2 headlamps on each mast. One shining uphill and one shining downhill to achieve a more even illumination of the slope.
Rustproof, resistant to rain, snow and ice. The headlamps can remain mounted all year round.

With Power LED Osram
Luminous flux reduction : L90B10 50000h
Lifetime : approx. 100000 hrs.
Light colour: 4000K neutral white (from 10 pcs. also 3000K or 5700K)
Colour rendering: Ra > 70
Luminous flux: 31000 Lm - comparable to a 400W metal halide high pressure lamp.
Driver: Philips Xitanium
Operating voltage: 202 - 254V 50 / 60Hz
Overvoltage protection: 4 kV (6kV)
Power consumption: 220 Watt
Power factor: 0.98
Flicker: < 4%
With short connecting cable and waterproof cable coupling
With pressure compensation valve
Permissible ambient temperature: - 20°C ... +50°C (also -45°C ... +55°C at extra charge)
Housing: die-cast aluminium, grey, with swivelling mounting bracket.
Wind load: 0.036m²
Protection class: IP66
Impact resistance: IK08
Dimensions: Height 610, width 420, depth 80 mm
Weight: 5,7 kg

Outdoor Flood Lights up to 150W



**LED Floodlight for Building Site
140W**



Very bright LED spotlight 140 Watt, for cranes and construction sites. As bright as 1500W halogen light.
LA-1731

Suitable for long beam distances of 20 - 45 metres.
The headlamps are tough during set-up, transport and vibrations.
Increased safety (the light is immediately bright).
Maintenance-free (10 years of normal operation without changing lamps).
LED floodlight has the advantage of energy saving (50 - 90%),
With large dimensioned heat sink for better heat distribution and long life expectancy.
Large optical lenses for bright and even light distribution.
They withstand bad weather, snow and rain and can remain mounted all year round.

Light distribution: 90
Lifetime: approx. 50000 hours
Light colour: 4000 K natural white
Luminous flux: 14900 Lm
Operating voltage: 100 - 240V 50 / 60Hz
Frequency: 50 / 60Hz
Power consumption: 150 Watt
Power factor: > 0.9
Housing: Die-cast aluminium, dark grey powder-coated.
Cover: Clear tempered glass, flat 4mm.
Swivel bracket: 180 degrees
Ambient temperature range: -20°C to + 50°C
Protection class: IP65, splash-proof.
Impact resistance: IK10
Dimensions: Width 440, height 240, depth 155 mm
Weight: 5,7 kg

LED Outdoor Flood Lights 180W - 500W and Halogen



LED Floodlight for Building Site Crane 500

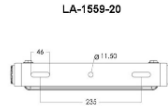

Very bright LED spotlight 136 Watt, for cranes and construction sites. With over 18,800 lumens - replaces a 400W HQI discharge lamp spotlight or 2000W halogen lamp. LA-1731-2

Suitable for long beam distances of 20 - 50 metres. The floodlights are tough during assembly, transport and vibrations. Increased safety (the light is immediately bright) Maintenance-free (10 years of normal operation without lamp replacement). LED floodlight has the advantage of energy saving (50 - 90%), With large dimensioned heat sink for better heat distribution and long life expectancy. With lens optics for bright and even light emission, far down where the light is needed. The crane light withstands bad weather, snow and rain and can remain mounted all year round.

- Light distribution: 45 deg
- With Power LED Osram
- Luminous flux reduction: L90B10 50000h
- Lifetime : approx. 100000 hrs.
- Light colour:: 4000K neutral white (from 10 pcs. also 3000K or 5700K)
- Colour rendering: Ra > 70
- Luminous flux:: 18800 Lm - comparable to a 400W metal halide high pressure lamp.
- Driver:: Philips Xitanium
- Operating voltage: 202 - 254V 50 / 60Hz
- Overvoltage protection: 4 kV (6kV)
- Power consumption: 136 Watt
- Power factor: 0.98
- Flicker: < 4%
- With short connecting cable and waterproof cable coupling
- With pressure compensation valve
- Permissible ambient temperature: - 20°C ... +50°C (also -45°C ... +55°C at extra charge)
- Housing: die-cast aluminium, grey, with swivelling mounting bracket.
- Wind load: 0.028m²
- Protection class: IP66
- Impact resistance: IK08
- Dimensions: Height 442, width 347, depth 64 mm
- Weight: 5,7 kg



LED Floodlight for Building Site Crane 1000

LA-1558-20



Very bright LED spotlight 300 Watt, for cranes and construction sites. With over 40,000 lumens - replaces a 1000W HQI discharge lamp spotlight. LA-1731-3

Suitable for long beam distances of 20 - 60 metres. The floodlights are tough during assembly, transport and vibrations. Increased safety (the light is immediately bright) Maintenance-free (10 years of normal operation without lamp replacement). LED floodlight has the advantage of energy saving (50 - 90%), With large dimensioned heat sink for better heat distribution and long life expectancy. With lens optics for bright and even light emission, far down where the light is needed. The crane light withstands bad weather, snow and rain and can remain mounted all year round.

Light distribution: 45 deg
 With Power LED Osram
 Luminous flux reduction: L90B10 50000h
 Lifetime : approx. 100000 hrs.
 Light colour:: 4000K neutral white (from 10 pcs. also 3000K or 5700K)
 Colour rendering: Ra > 70
 Luminous flux:: 40700 Lm - comparable to a 600W sodium or metal halide high pressure lamp.
 Driver:: 2x Philips Xitanium
 Operating voltage: 202 - 254V 50 / 60Hz
 Overvoltage protection: 6kV
 Power consumption: 264 Watt
 Power factor: 0.98
 Flicker: < 4%
 With short connecting cable and waterproof cable coupling
 With pressure compensation valve
 Permissible ambient temperature: - 20°C ... +50°C (also -45°C ... +55°C at extra charge)
 Housing: die-cast aluminium, grey, with swivelling mounting bracket.
 Wind load: 0.028m²
 Protection class: IP66
 Impact resistance: IK08
 Dimensions: Height 610, width 420, depth 80 mm
 Weight: 5,7 kg



LED Floodlight for Building Site 180W



LA-1578

Very powerful LED projector 180 watt for cranes and building sites. The brightness is like a 2000W halogen floodlight. LA-1731-4

Suitable for long beam distances of 20 - 50 metres. The headlamps are tough during set-up, transport and vibrations. Increased safety (the light is immediately bright). Maintenance-free (10 years of normal operation without changing lamps). LED floodlight has the advantage of energy saving (50 - 90%), With large dimensioned heat sink for better heat distribution and long life expectancy. Large optical lenses for bright and even light distribution. They withstand bad weather, snow and rain and can remain mounted all year round.

Light distribution: 90
 Lifetime: approx. 50000 hours
 Light colour: 4000 K natural white
 Luminous flux: 17900 Lm
 Operating voltage: 100 - 240V 50 / 60Hz
 Frequency: 50 / 60Hz
 Power consumption: 180 Watt
 Power factor: > 0.9
 Housing: Die-cast aluminium, dark grey powder-coated.
 Cover: Clear tempered glass, flat 4mm.
 Swivel bracket: 180 degrees
 Ambient temperature range: -20°C to + 50°C
 Protection class: IP65, splash-proof.
 Impact resistance: IK10
 Dimensions: Width 440, height 240, depth 155 mm
 Weight: 5,7 kg

Outdoor Floodlights with IR Sensor



Power LED Floodlight with IR Sensor 10W (80W)



Powerful LED projector 8.5 watt with motion detector, with the brightness of 80 watt halogen light.
LA-1950

Very wide and uniformly bright beam 120°.
With power LED
Detection distance: 1-6m adjustable
Light colour 4200 K natural white.
Luminous flux 750 Lm - comparable to 80W halogen or 100W incandescent light.
Built-in ballast.
Operating voltage 230V 50 / 60Hz
Power consumption 11 Watt
Housing: die-cast aluminium black (from 10 pcs. grey or white can be ordered)
with mounting bracket.
Adjustable inclination
Installation height 2-4m
Light duration adjustable 10 seconds up to 8 minutes
Sensitivity adjustable 5 - 1.000 Lux
Connection cable with a length of 20cm
Protection class: Spotlight IP65, IR sensor IP44
Dimensions: Width 120, height 150, depth 105 mm
Weight: 4,1 kg



Power LED Floodlight with IR Sensor 30W (250W)

Powerful LED projector 30 watt with motion detector, with the brightness of 250 watt halogen light.
LA-1954

Accessories for outdoor fixtures



Shades For IP MX 1000 / 1500
LA-2058



Protection Grill for IP MX 1500 Flood
LA-2059

Narrow Beam Spotlights Outdoor



Halogen Spotlight Outdoor MX-75



Low-volt quartz spotlight for signboards / billboards. Black or white IP55. Can be dimmed or operated on IR sensors.
LA-2190S

For lighting in the garden, trees, surveillance camera, sign, machine, etc.
Operable via dimmer for garden venue or event/performance.
Immediately bright light, no warm-up time. Also suitable for motion detectors.
Hardly any lateral glare and better light concentration due to round reflector.
Long lamp life due to low-voltage halogen technology.
Lower power consumption with the same luminous range compared to 300W halogen floodlights.

Beam angle: 8°, 24° or 45° depending on the lamp used.
Lighting examples: 0.9m light circle (with 8° lamp at 6m distance) or 1.3m light circle (24° lamp at 3m light distance).

Built-in transformer.
Connection voltage: 230V
Solid aluminium die-cast housing
Protection class IP55
Dimensions: Width 185mm, height 150mm (255mm with bracket), depth 140mm.

Please order separately: Halogen lamp Halospot 111, 50W - 75 Watt in 8° - 45°.
Weight: 2,6 kg

Worklights for Rescue, Fire Brigade, Building Site



Fire Brigade LED Floodlight Rescue 100W/160W



Compact, portable LED worklight for quick outdoor use. (As bright as 1000/1500 watt halogen spotlight).
LA-3052

Powerful weatherproof LED floodlight with low heat emission. For fire brigade, emergency rescue, police or military applications. Shockproof and resistant to vibration. No waiting time, instant starting with full brightness. Working distance: For close areas, max. 35 meter. With robust fish eye glass lenses for symmetrical light distribution. Good colour rendering

Beam spread: 90 deg
service life of the LEDs: aprx. 50,000 h
Lumen output: 10100 / 14200 lm
Light colour: 4000K pure white
Operating voltage: 200 - 24V 50-60Hz (12V/24V on request)
Suitable for generator operation: Insensitive to voltage fluctuations, low starting current.
Energy saving: Power consumption only 105/160 watt
With PWM driver.
High ambient temperature range: -20°C bis + 50°C
Vibration-proof construction.
With 10m rubber cable and a bayonet schuko connector IP68. (others on request)
Black aluminium die-cast housing, with adjustable hanging bracket.
With tube for 30mm standard quick fasting bolt.
Protection class IP 65 waterproof.
CE approved.
Dimensions: w 390/440mm, h 250mm, d 155mm
Weight: 5 kg



Fire Brigade LED Floodlight Rescue 180W

Mobile luminary with 180 watt power LED lamp. With the light intensity of 1800 watt halogen.
LA-3052-18

Work Lights



Rigid Halogen Work Light 400W (500W) with Tripod

Mobile halogen floodlight with stable, height-adjustable stand for indoor and outdoor use. Only limited quantity available.

With protective screen and height-adjustable stand
Height 80cm to 180cm
The spotlight can be swivelled and has a 3m rubber connecting cable with a shock-proof plug.
Please order separately: Lamp/Halogens R7s 300W or 400W.
Protection class IP54 (insensitive to paint splashes, plaster or water jets).
Vibration-proof according to IK08

a protective grille can be ordered as an option.
LA-3060



Work Light Stand 2* 30W LED

Portable LED floodlight with height-adjustable tripod stand for indoor / outdoor use.

2 adjustable luminaires with adjustable stand

Max. height: 164 cm
Connection cable: 1.5m long with schuko plug.
Light colour: 4000K
Lumens: 6000 Lm
Voltage: 230V
Painting: dark grey
Protection degree: IP65
LA-3062L

Worklights for Rescue, Fire Brigade, Building Site



Mobile Flood Light Tripod 3m Stand long throw 2x140W LED (3000W)

Portable double LED worklight, with 3 meter high stand. As bright as 2 halogen floodlights, For indoor / outdoor use.

2 floodlights for immediate use on construction sites, accidents, maintenance, repair, salvage, rescue, etc.
Shockproof and resistant to vibrations, as there exists no lamp filament, due the LED lamp.
No waiting time - instantly full brightness.
Including Power LED lamp 30000 h life time.
Height adjustable stand 150cm to 320cm height.
Stable steel construction, galvanized.
10m long connection cable with schuko plug.
Voltage: 200-240V
Power consumption 300W
Protection degree IP65 (waterproof)
LA-3063

Work Lights



LED Work Light Tripod 50W/100W/140W

Very rigid tripod stand, height-adjustable with bright LED floodlight for indoor / outdoor use.

Work headlamp with low heat output.
Insensitive to vibrations, as there is no filament, but LED.
When switching on, the spotlight immediately has full brightness.
With LED bulb 30 000 hrs. lifetime.

Optionally available:
With 50W Power LED light (corresponds to 400W halogen) with 100W (as bright as 1000 watts of halogen light) or 140W (as bright as 1400W halogen light)

Height adjustable tripod 100cm to 250cm height.
Stable steel construction, galvanized. With brackets for cable winding.
The spotlight is swivelable and has 5m rubber connection cable with Schuko plug.
Connection voltage 230V 50Hz
Power consumption 50W, 100W or 140W
Protection class IP65 (insensitive to paint splashes, plaster, dust or jet water)
LA-3064

Worklights for Rescue, Fire Brigade, Building Site



Battery Work Light with Stand 30 (300W) LED

Battery operated, portable LED floodlight, powerful with height-adjustable tripod stand for indoor / outdoor use.

Battery powered floodlight for immediate use on construction sites, accidents, maintenance, repair, salvage, rescue, etc.
Shockproof and resistant to vibrations, as there exists no lamp filament, due the LED lamp.

No waiting time - instantly full brightness.
Including Power LED lamp 30000 h life time.
With a 30W LED floodlight (as bright as 300 watt halogen light)
Height adjustable stand 100cm to 250cm height.
Stable steel construction, galvanized.
The luminaire is adjustable.

Autarkic operation time approx 5 hours.
By the integrated charger, the battery can be recharged via any 230V power supply. So the continuous operation of the work light is possible.
Internal Battery 12 V
Power consumption 35W
Protection degree IP65 (waterproof)

As a special solution, we also offer solar-powered lights.
LA-3065B

Work Lights



Portable LED Work Light with handle and Batteries IP44



Mobile LED Rechargeable Portable Worklight for indoor, service, outdoor, car and boat.
LA-3066-1

With bright white SMD LED.
(Comparable with 100 watt halogen).
The projector can be tilted upward horizontally or vertically.
With high power lithium ion battery 8.4V.
For charging a 230V grid adaptor and a car adaptor are included.

Operating time: About 4 hours on one full charge.
Charging time: 6 hours.
Power: 10W
Light colour: 4000K pure white
With steel support frame and a cool plastic grip.
Protection: IP44
Dimensions: w 125 * d 115 * h 250mm
Weight: 2 kg



Portable LED Work Light with Batteries 20W (200W) IP44



Mobile and bright LED Rechargeable Portable Worklight for indoor, service, outdoor, car and boat.
LA-3066-2

With bright white COB LED.
The projector can be tilted upward horizontally or vertically.
Brightness: 1800 Lm
Operating on the internal battery or on the power grid.
A 230V adaptor and car adaptor are included.
LED indicator lights for charge control and low battery warning.

Operating time: 3 hours on one full charge.
Charging time: 4 to 5 h
Operating voltage: 85V - 265V AC
Power: 30W
Battery: LiO longlife battery.
Aluminium support frame and a cool plastic grip.
Protection: IP44
Dimensions: 245 * 220 * 205mm
MOQ: 8 pcs.
Weight: 2,9 kg





Portable LED Work Light with Batteries 30W (300W) IP44

Mobile and bright LED Rechargeable Portable Worklight for indoor, service, outdoor, car and boat.
LA-3066-3

With bright-white COB LED.
The spotlight can be swivelled in all directions.
Brightness: 2500 Lm
Operation via the internal battery or via the power grid possible.
A 230V adapter and car charging cable are included for charging.
LED indicator lights for charging control and battery status warning.

Battery life: 3 hours with a full battery charge
Charging time: 4 to 5 h
Operating voltage: 85 – 265V AC and 12V DC.
Batteries: LiO Battery 900mAh Ni-MH included.
Aluminium frame and cool plastic handle.
Protection class: IP65
Dimensions: 225 * 295 * 135mm
Weight: 2,9 kg

Worklights for Rescue, Fire Brigade, Building Site

	<p>Mobile Work Light with Battery and Stand 30 (300W) LED</p>	<p>Battery powered floodlight for immediate use on construction sites, accidents, maintenance, repair, salvage, rescue, etc. Shockproof and resistant to vibrations, as there exists no lamp filament, due the LED lamp. No waiting time - instantly full brightness.</p> <p>Including Power LED lamp 30000 h life time. With a 30W LED floodlight (as bright as 300 watt halogen light) Height adjustable stand 100cm to 250cm height. Stable steel construction, galvanized. With brackets for cable tumbling. The luminaire is adjustable and has a 5m long connection cable with plug. The connection cable is plugged into the battery box, so the flood lights are ready to use. In the portable battery box also the floodlights and cables are located, for easy transportation. Autarkic operation time approx 7 hours. By the integrated charger, the battery can be recharged via any 230V power supply. So the continuous operation of the work light is possible. Internal Battery 12 V Power consumption 35W Protection degree IP65 (waterproof) Gross weight of the box: 24kg As a special solution, we also offer solar-powered lights. LA-3067B</p>
	<p>Mobile Work Light with Battery and Stand 100 (1000W) LED</p>	<p>Battery powered floodlights for immediate use on construction sites, accidents, maintenance, repair, salvage, rescue, etc. Shockproof and resistant to vibrations, as there exists no lamp filament, due the LED lamp. No waiting time - instantly full brightness.</p> <p>Including Power LED lamp 30000 h life time. Available with a 100W LED light (as bright as 1000 watt halogen light) or with 2 floodlights (2 * 1000W). Height adjustable stand 100cm to 250cm height. Stable steel construction, galvanized. With brackets for cable tumbling. The luminaire is adjustable and has a 5m long connection cable with plug. The connection cable is plugged into the battery box, so the flood lights are ready to use. In the portable battery box also the floodlights and cables are located, for easy transportation. Autarkic operation time approx 7 hours. By the integrated charger, the battery can be recharged via any 230V power supply. So the continuous operation of the work light is possible. Internal Battery 12 V Power consumption 120W or 240W Protection degree IP65 (waterproof) Gross weight of the box: 37kg (1 floodlight) / 53kg (2 floodlights) As a special solution, we also offer solar-powered lights. LA-3067C</p>

Tripods, Lifts



Mobile Lighting Tower with Lift 800cm and 4 LED Floodlights



Rolling lifting tower with 4 LED headlights 4x 140W, TÜV approved. Max height 8m. Crank drive. LA-3068-8

Flood lighting fixture, equipped with 4 pcs. high power LED floodlights 100W. Recommended for building sites, mining, camps and events in sunny regions, like desert countries, Africa, Arabia, South America. With wheels for horizontal or vertical transport by one person. The lift can be risen by a crank up to 8 meters high. The winch is protected against falling down. Operation indoors and outdoors.

With 10m spiral power cable and open wires, that the customer can easily mount any mains connector plug.

Floodlight specifications:

The brightness is like 4 halogen floodlights each 1000 watt. 4 pcs. LED floodlights 100 watt. Each one is adjustable to any direction.

LED:	Epistar Power LEDs
Lumens:	total 75000 Lm
Light color:	4000K natural white
Lighted area Ø	aprx. 60 meter
Colour index:	CRI > 80
Light distribution:	90°
Operating voltage:	220V - 240V (on request also for 12V-24V battery voltage.)
Frequency:	50 / 60Hz
Large ambient temperature range:	-20°C to + 50°C
Protection degree:	IP65, splashproof
Impact resistance:	IK10

Electrical specifications:

Voltage:	220V - 240V
Frequency:	50 / 60Hz
Power consumption:	560W
Power factor:	> 0.9

20 Years sparepart availability guarantee.

Dimensions:

Height	8000mm
Width	2.20m
Size, if closed:	2195 x 760 x 825 mm
Approvals:	CE, RoHS, WEEE

* The pictures show samples with different sizes.
Weight: 212 kg

Work Lights

Mobile Work Light Hobby 36W (180W) IP44

Mobile work spotlight for indoor and outdoor use. With fluorescent lamps, low heat emission. Equivalent to 180W halogen light. For building site, renovation and painters. LA-3074

Tripods, Lifts



Tripod Stand for Building Site 4.5 meters LA-3077

Tripod Stand for Building Site Magnum 72 / 108 LA-3078

Small Tripod Stand for Work Light Magnum 36 LA-3079

Worklights for Rescue, Fire Brigade, Building Site

**LED Work Light 12V - 24V Car
and Boat IP67 18W**

Small waterproof LED rescue search and work light for car, truck, boat or industry. IP67
LA-3081

An ideal floodlight and searchlight for use in all motor vehicles, both civil (boats, cars, camper vans...) or industrial (ships, cranes, earth moving machines, bulldozers, fork lifts...)
Complete with power LED (30000 h).

Very high light intensity 1800 lm

Light colour: 6500K daylight white.

Beam spread: 60° (on order 25°)

Max. Lighting distance: 8m / 1 Lux

Protection degree IP67

Dimensions: Ø 130mm, depth 50mm.

Floodlight with aluminium die-cast body extremely robust and compact, Sealed, waterproof and maintenance free.

With a steel swivel mounting bracket through a coil, helping absorption of vibrations and also allowing small aiming adjustments.

Flexible supply voltage range from 9V to 30V DC allowing use with batteries, small generators and also in combination with solar photovoltaic panels.

The floodlight is well apt for lighting tasks on boats and industrial vehicles with a power consumption of only 18W and a powerful light beam.

Use: A LED work light with high efficiency and minimal power consumption requiring a very low voltage power supply and with an high IP67 protection degree. Also able to function with a flexible supply range from 9 to 30V DC that allow usage

also with energy coming from photovoltaic solar panels.

A secure use in all situations where electrical safety needs require or suggest to employ low voltage.

On demand it can be supplied for use at line voltage (220/240 V).

In such case is required an external 12 volt power supply to be set separately, as the waterproof model available as an accessory.

Construction: die-cast aluminium body and antiscratch coated polycarbonate protection diffusor.

Equipped with a cable and a couple of waterproof connectors for a quick power connection.

The floodlight is supplied hermetically sealed. No maintenance is required.

Weight: 0,65 kg



LED Worklight 12V - 24V IP68 48W (300W)

Compact waterproof
LED Rescue work and
search light for car,
truck, boat or industry.

An ideal floodlight and searchlight for use in all motor vehicles, boats, fire brigade cars, rescue, camper vans...)

or industrial (ships, cranes, earth moving machines, bulldozers, fork lifts...)

Complete with power LED (40000 h).

The brightness is like 300 watt halogen light.

Very high light intensity 4050 lm,

Light colour: 6500K daylight white.

Beam spread on order: 90° wide or with 8° long distance search light

Max. lighting distance at the 8° model: 250 meter / 1 Lux

Max. lighting distance at the 90° model: 25m / 1 Lux

Brightness at the 8° model: 256 Lux in 14m distance

Brightness at the 90° model: 26 Lux in 5m distance, 7m illuminated surface

Protection degree IP68

Dimensions: Ø 180mm, depth 100mm.

Foodlight with aluminium die-cast body extremely robust and compact,

Sealed, waterproof and maintenance free.

Mounted on a steel swivel mounting bracket.

Most relevant peculiarity is the ability to operate under a really flexible supply ranging from 10V to 30V DC allowing use with batteries, small generators and also in combination with solar photovoltaic panels.

The floodlight is well apt for lighting tasks on boats and industrial vehicles with a power consumption of only 48W and a powerful light beam.

Use: A LED work light with high efficiency and minimal power consumption requiring a very low

voltage power supply and with an high IP68 protection degree. Also able to function with a flexible supply range from 10 to 30V DC that allow usage also with energy coming from photovoltaic solar panels.

A secure use in all situations were electrical safety needs require or suggest to employ low voltage.

The searchlight also guarantees a limited surface temperature and a cold emitted light beam, with absence of U.V. emissions.

220/240V operation is possible with an additional, external 24 volt power supply. This power supply is available as an accessory.

Construction: die-cast aluminium body and antiscratch coated polycarbonate protection diffusor.

Equipped with a rubber cable.

LA-3084



**LED Searchlight 12V - 24V IP68
90W (600W)**

Compact waterproof LED Rescue work and search light for car, truck, boat or industry. Extreme bright.

An ideal floodlight and searchlight for use in all motor vehicles, both civil (boats, cars, camper vans...) or industrial (ships, cranes, earth moving machines, bulldozers, fork lifts...)

Complete with power LED (40000 h).

The brightness is like 600 watt halogen light.

Very high light intensity 8100 lm,

Light colour: 6500K daylight white.

Beam spread on order: 90° wide or with 8° long distance search light

Max. lighting distance at the 8° model: 400 meter / 1 Lux

Max. lighting distance at the 90° model: 40m / 1 Lux

Brightness at the 8° model: 256 Lux in 20m distance

Brightness at the 90° model: 26 Lux in 7m distance, 11m illuminated surface

Protection degree IP68

Dimensions: Ø 180mm, depth 100mm.

Floodlight with aluminium die-cast body extremely robust and compact, Sealed, waterproof and maintenance free.

Mounted on a steel swivel mounting bracket.

Most relevant peculiarity is the ability to operate under a really flexible supply ranging from 10V to 30V DC allowing use with batteries, small generators and also in combination with solar photovoltaic panels.

The floodlight is well apt for lighting tasks on boats and industrial vehicles with a power consumption of only 90W and a powerful light beam.

Use: A LED work light with high efficiency and minimal power consumption requiring a very low voltage power supply and with an high IP68 protection degree. Also able to function with a flexible supply range from 10 to 30V DC that allow usage

also with energy coming from photovoltaic solar panels.

A secure use in all situations were electrical safety needs require or suggest to employ low voltage.

The searchlight also guarantees a limited surface temperature and a cold emitted light beam, with absence of U.V. emissions.

220/240V operation is possible with an additional, external 24 volt power supply. This power supply is available as an accessory.

Construction: die-cast aluminium body and antiscratch coated polycarbonate protection diffusor.

Equipped with a rubber cable.

LA-3085



LED Work Light 12V - 24V IP69K 28W



Small waterproof LED worklight for 12v, 24 volt battery.
For machines, boat, car or industry. Extrem high protection degree.
LA-3087K

An ideal floodlight for use in most battery operated vehicles, both civil (ships, mines, camper vans...) or industrial (ships, cranes, earth moving machines, bulldozers, fork lifts...)
Complete with power LED (30000 h).

Very high light intensity 2700 lm,
Light colour: 6000K daylight white.
Beam spread 60°
Protection degree IP69K

Dimensions: Hight 137mm, width 110mm, depth 55mm.
Floodlight with aluminium die-cast body extremely robust and compact,
Sealed, waterproof and maintenance free.

With a steel swivel mounting bracket through a coil, helping absorption of vibrations and also allowing small aiming adjustments.
Flexible supply voltage range from 9V to 30V DC allowing use with batteries, small generators and also in combination with solar photovoltaic panels.
Power consumption of only 28W and a powerful light beam.

Use: A LED work light with high efficiency and minimal power consumption requiring a very low voltage power supply and with an high IP69K protection degree. A secure use in all situations where electrical safety needs require or suggest to employ low voltage.

On demand it can be supplied for use at line voltage (220/240 V). In such case is required an external 12 volt power supply to be set separately, as the waterproof model available as an accessory.

Construction: die-cast aluminium body and antiscratch coated polycarbonate protection diffusor.

Equipped with a cable and a couple of waterproof connectors for a quick power connection.

The floodlight is supplied hermetically sealed. No maintenance is required.

Weight: 0,75 kg

**LED Worklight 12V - 24V IP67
48W**

Compact waterproof LED Rescue work and search light for car, truck, boat or industry.

An ideal floodlight and searchlight for use in all motor vehicles, boats, fire brigade cars, rescue, camper vans...) or industrial (ships, cranes, earth moving machines, bulldozers, fork lifts...) Complete with power LED (30000 h).

The brightness is like: 300 watt halogen light.
 Very high light intensity: 3120 lm
 Light colour: 6500K daylight white
 Beam spread on order: 60° wide or with 30° search light
 Voltage: 10V - 30V DC
 Ambient temperature: -40°C ~ +60°C
 Casing: Aluminium, black
 Protection degree: IP67
 Dimensions: Height 137mm, width 110mm, depth 55mm

Floodlight with aluminium die-cast body extremely robust and compact, Sealed, waterproof and maintenance free.

Mounted on a steel swivel mounting bracket.

Most relevant peculiarity is the ability to operate under a really flexible supply ranging from 10V to 30V DC allowing use with batteries, small generators and also in combination with solar photovoltaic panels.

The floodlight is well apt for lighting tasks on boats and industrial vehicles with a power consumption of only 48W and a powerful light beam.

Use: A LED work light with high efficiency and minimal power consumption requiring a very low voltage power supply and with an high IP67 protection degree. Also able to function with a flexible supply range from 10 to 30V DC that allow usage also with energy coming from photovoltaic solar panels.

A secure use in all situations were electrical safety needs require or suggest to employ low voltage.

The searchlight also guarantees a limited surface temperature and a cold emitted light beam, with absence of U.V. emissions.

220/240V operation is possible with an additional, external 24 volt power supply. This power supply is available as an accessory.

Construction: die-cast aluminium body and antiscratch coated polycarbonate protection diffusor.

Equipped with a rubber cable.

LA-3088



LED Work Light 12V - 24V IP67 60W (400W)



Small waterproof LED worklight for 12v, 24 volt battery. For machines, boat, car or industry.
LA-3089

An ideal floodlight for use in most battery operated vehicles, both civil (ships, mines, camper vans...) or industrial (ships, cranes, earth moving machines, bulldozers, fork lifts...)
Complete with power LED (30000 h).

Very high light intensity 6100 lm,
Light colour: 6000K daylight white.

Beam spread 10°

Protection degree IP67

Dimensions: Ø 130mm, depth 50mm.

Floodlight with aluminium die-cast body extremely robust and compact,
Sealed, waterproof and maintenance free.

With a steel swivel mounting bracket through a coil, helping absorption of vibrations and also allowing small aiming adjustments.

Flexible supply voltage range from 9V to 30V DC allowing use with batteries, small generators and also in combination with solar photovoltaic panels.
Power consumption of only 27W and a powerful light beam.

Use: A LED work light with high efficiency and minimal power consumption requiring a very low voltage power supply and with an high IP67 protection degree. A secure use in all situations where electrical safety needs require or suggest to employ low voltage.

On demand it can be supplied for use at line voltage (220/240 V). In such case is required an external 12 volt power supply to be set separately, as the waterproof model available as an accessory.

Construction: die-cast aluminium body and antiscratch coated polycarbonate protection diffusor.

Equipped with a cable and a couple of waterproof connectors for a quick power connection.

The floodlight is supplied hermetically sealed. No maintenance is required.

Weight: 0,75 kg

Sign Board Lighting



LED Lighting for Market Stall with Battery



Mobile, independent lighting set with 2 LED spotlights for sales stand, Christmas market, sales trolley, street vending.
LA-3200

Complete package with 2 LED floodlights, battery and charger.
Operating time 14 h at fully charged battery.

Ready to mount including set-up plan and:

2 LED flood light fixtures 10 watt, corresponding to 2x 100 watt incandescent lamps,

(Alternatively with 2 LED light bars 100cm long available).

1 High power gel battery 12 volt, maintenance-free,

1 charger,

10 m cable

Weight: 39 kg

Work Lights



Portable LED Work Light with handle and Batteries



Mobile LED Rechargeable Portable Worklight for indoor, service, outdoor, car and boat.
LA-3210

With bright white SMD LED.
(Comparable with 100 watt halogen).
The projector can be tilted upward horizontally or vertically.
With high power lithium ion battery 8.4V.
For charging a 230V grid adaptor and a car adaptor are included.

Operating time: About 4 hours on one full charge.
Charging time: 6 hours.
Power: 10W
Light colour: 4000K pure white
With steel support frame and a cool plastic grip.
Protection: IP44
Dimensions: w 125 * d 115 * h 250mm
Weight: 2 kg

Lighting for container and accomodations



LED Light Bar Aluminium 0.5m for Outdoor lighting



Rigid and waterproof aluminium bar with powerful 12V LEDs for urban lighting.
LA-LD-L106

Impact-resistant aluminium strip with a service life of over 12 years.
Also suitable for truck loading space illumination, for set-up vehicles and loading bridges, for shop windows.
Extremely bright LEDs with 50,000 h service life.

Light colour: 4000K bright white (on special order also warm white 3000K, red, yellow, green or blue).
Light intensity: 450 lumen
Operation via: 230V with transformer or via 12V battery.
Connected voltage: 12V DC / 0,36A

At both ends approx. 30cm connection cable with round, splash-proof connectors.
The lamp is fixed with stainless steel clips (order separately).

Beam angle approx.: 120
Power consumption: 4,5 Watt
Splash-proof: IP65
Length 50cm, width 23mm, height 11mm
Weight: 0,3 kg

Fountain lighting and water feature lighting



LED Light Bar Aluminium 1m for Outdoor lighting

Rigid and waterproof aluminium bar with powerful LEDs 12V for urban lighting.
LA-LD-L107

LED Sticks and Bars



LED Lighting Truck Load Compartment 24V 120cm



Robust LED line light, waterproof IP65. Suitable for indoors or outdoors, for lighting truck cargo compartments, coaches, boats, railways or industrial facilities.

The brightness corresponds to a T8 58W tube.
LA-LD-L108A

Stable aluminium profile rail with a service life of over 12 years. Also suitable for truck loading space lighting, for set-up vehicles and loading bridges, for boats or for outdoor lighting.

Inexpensive replacement for the fluorescent tubes used up to now: No tube change, lower battery consumption, no ballast required. Extremely bright SMD LEDs with 50,000 h lifetime.

Light colour 6000K daylight white (warm white 3000K also available on special order).

Light intensity: 1920 Lm

Beam angle: wide approx. 120

Supply voltage 24V DC

Power consumption: 0,8A

Power consumption: 20 Watt

2 connecting cables: approx. 25cm long

Screw fixing via 2 lugs at the ends or with the adhesive strip on the back.

Splash-proof IP65

Impact resistance: IK08

Dimensions: Length 1000mm, width 20mm, height 10mm

Weight: 0,3 kg

Fountain lighting and water feature lighting



Facade LED Line Bar 24W white 1m



LED bar with bright white light 24W.

For lighting indoors and outdoors for advertising signs, buildings or facades.
LA-LD-L111

Bright Superflux LEDs (white or coloured)

The LED strips have short connecting leads with plugs on both sides, making it easy to operate them several metres apart.

Light distribution approx. 40 degrees

With power supply: 220V-240V AC

Internal voltage: 24V DC

Dimensions (L x W x H): 1000 x 20 x 16 mm

Other lengths 0.3m, 0.5m, 0.6m, 1.2m (from 20 pcs.)

Housing made of anodised and lacquered aluminium

Toughened glass T = 3mm satin finish

Aluminium bracket rotates 90

Protection class: IP67 splash-proof

with waterproof connectors (IP67)

For the RGB model, please order a suitable DMX controller separately.

Weight: kg

Architectural and Facade Lighting



LED Outdoor Spotlight MX Spot 8° Colour Change RGB DMX



LED spotlight with coloured light, controllable via DMX-512 interface. Narrow light beam for illuminating advertising signs, facade light strips or objects outdoors IP55.

Quality from Italy. Remaining stock: 1 piece demonstration unit
LA-LD70CW

LED spotlight with coloured light, controllable via DMX-512 interface. Narrow light beam for illuminating advertising signs, facade light strips or objects outdoors IP55. Quality from Italy.
Remaining stock: 1 piece demonstration unit

Weatherproof spotlight according to IP 55 for outdoor use. Contains 4 modules, each with 3 high-power LEDs in red, green and blue. Creates a light strip on the house wall or for spotlighting at a distance of up to 10 metres.

Depending on the light control used, any fixed light colours can be set or slow and fast colour transitions.

Control via any DMX-512 lighting control system.

The LEDs have a total power of 12 W

Beam angle: 8° narrowly focused

Lifetime 50,000 h

Supply voltage 230V or 24V DC

Power consumption 15W

Housing die-cast aluminium black

Dimensions: H 305mm, W 185mm, D 140mm

Weight: 2,45 kg



LED Wall Washer Bar Outdoor RGB Colour



30W Power LED outdoor luminary with DMX control and colour mixing.
LA-LD80C

Remaining stock: 1 piece

Weatherproof spotlight according to IP 65 for outdoor use.

With 240 power LEDs in red, green and blue.

The LEDs have a total power of 30 W.

Beam angle: 10° (optionally 25° or 40°).

Service life 50,000 h

Several of these stealers can be synchronised.

Control via optional IR remote control or via DMX-512 possible.

The bars have short connecting cables 20cm with connectors.

This makes it easy to connect several modules.

If larger distances between the bars are required, extension cables must be used for data and power supply.

Supply voltage 230V 50Hz

Power consumption 35W

Housing aluminium

Dimensions: L 1000mm, W 80mm, H 75mm

Weight: 4,5 kg

Garden, Post and Bollard Lights



Garden Post Light Style

Rigid and energy saving outdoor stand light 7W = as bright as 35W halogen.
LA-PF017

Cast aluminium with polycarbonate diffuser.

Incl. energy-saving bulb GX53 7W.









As path lighting for miniature golf, park, garden or paths.







protection: IP54, class 1







colour: grey



dimensions: 250 x 165 x 610mm

Weight: kg

	<h3>Stainless Steel Post Light Pisa</h3>	<p>Decorative post light 70cm for garden lighting or path lighting. Discontinued article - remaining stock 1 piece LA-PF042</p>
<p>Very beautiful design with even light distribution. With E27 socket for 230V bulbs up to max. 60W. Including energy saving lamp E27 12W. Splash-proof IP33, protection class I.</p>		<p>Dimensions: Luminaire: Ø 110 mm Height: approx. 700 mm Base plate: Ø 127mm Material: stainless steel, shade thermoplastic satin, socket ceramic. Discontinued item - remaining stock ! Weight: 1,1 kg</p>
	<h3>Garden Post Light Zilly 1</h3>	<p>Stainless steel stand light with adjustable halogen spot. LA-PF045</p>
		<p>As pathway lighting or for illuminating of small objects. For GU10 lamps up to 35W max. 68mm long. Voltage: 220 - 240V Dimensions: Max height 50cm. width 15cm Protection: IP44 Weight: 1,1 kg</p>
	<h3>Garden Post Light Zilly 2</h3>	<p>Stainless steel stand light with 2 adjustable halogen spots. LA-PF046</p>
		<p>As path lighting or for illuminating small objects. For 2x bulbs GU10 up to 50W max. 55mm long. Operating voltage: 230V Height: 96cm, width: 24cm Protection class: IP44 Weight: 2,1 kg</p>
	<h3>Aluminium Bollard Light Orto LED</h3>	<p>Stable path light made of solid die-cast aluminium with lamella optics and LED or bright energy-saving lamp. Minimum order quantity 4 pieces - delivery time approx. 3-4 weeks. LA-PF062</p>
<p>With ring louvre optics for glare-free all-round illumination. With LED lamp</p>		<p>Power: 15W Light colour: 3000K warm white Luminous flux: 700 lumen The luminous intensity corresponds to about a 100W incandescent lamp Max. Power: 15,5W Operating voltage: 230V 50/60Hz Housing: die-cast aluminium, anthracite black Height: 1000mm Diameter: 120mm Protection class: IP54 Screws made of VA stainless steel Weight: 3,9 kg</p>
	<h3>Large Granite Garden Light Arrock</h3>	<p>70cm high bollard light for pathway, entrance, portal, public garden. For LED or halogen lamp GU10 LA-PF071</p>
		<p>Lamp: GU10 230V max. 35W Pls. order the lamp extra. Material: Granit / stainless stell Granit is a natural product. Each light fixture is a unicate. Colour: black/white Protection: IP44 Dimensions: width 19 cm, hight 70,5 cm, depth 9 cm Floor plate: (L / w): 9 / 19 cm Weight: 12,25 kg</p>





	<p>Stand Light LED Logs Low Outdoor</p> <p>Massive aluminium bollard light, 40cm high with LED, for pathway.</p>	<p>6W LED lamp, warm white 3000K Operating voltage: 230 Volt max. Power: 8 Watts Includes built-in LED driver material: Aluminum Anthracite (gray or silver) Protection degree: IP44 Length 13 cm Width 8 cm Height 39,5 cm LA-PF204</p>
	<p>Stand Light LED Logs Big Outdoor</p>	<p>Massive aluminium bollard light, 70cm high with LED, for pathway. LA-PF205</p>
	<p>Stand Light LED Cylinder Outdoor</p> <p>Bright and stable light post with LED for garden lighting or pathway.</p>	<p>Light source: 15W LED Light color: 3000K warm white Luminous flux: 1000 lm (comparable to 100 watt halogen) LED lamp inclusive Operating voltage: 230 volt ac max. Power: 15 watt Material: Aluminum die-cast Colour: Antracite grey</p> <p>This bollard light is prepared for through-wiring. Mounting accessories and LED driver is included.</p> <p>Ambient temperature: -15°C - +40°C Energy efficiency class: B Protection degree: IP 65 Dimensions: Height 80 cm, diameter 173mm LA-PF210</p>
	<p>Stand Light LED Outdoor CAT 1</p> <p>Rectangular and modern light post with LED, 50cm high for garden lighting or pathway.</p>	<p>Material: die-cast aluminium Colour: anthracite Operating voltage: 230V AC Power: 6W LED High Power Light colour: warm white 3000K Luminous intensity: 306 lm (comparable with 40W incandescent light) Radiation pattern: Downward flood Incl. LED power supply unit Ambient temperature: -15°C - +40°C Protection class: IP 54 Energy efficiency class: A Height: 500 mm, width 150 x 60 mm LA-PF213</p>
	<p>LED Garden Post Light Ross</p> 	<p>Rigid LED bollard and pathway lamp. 6W LED, as bright as 60 watt incandescent light. LA-PF220</p> <p>Bollard and pathway luminaire for garden, driveway, paths or parking. With LED 6 Watt Light color: 3000K warm white electronic ballast Operating voltage: 220 / 240V 50 / 60Hz Material: Die-cast aluminium Color: anthracite Protection: IP44, Class I Dimensions: Height 800mm, width 234mm, depth 176mm Base: 175mm x 95mm Weight: 4,5 kg</p>

	<h3>Aluminium Garden Post Light</h3>	<p>Slim aluminium garden light, path light, grey with frosted glass shade. LA-PF333</p> <p>Remaining stock: 1 piece</p> <p>Uniform, warm light. For energy saving lamp E27, max. 11W or drop lamp E27, max. 40 W. Please order bulb and cable separately ! Material: aluminium Colour: silver-grey Protection class: IP54 Dimensions: Height approx. 64cm, Diameter base approx. 11,5cm, diameter lamp approx. 6.5 cm Weight: kg</p>
	<h3>Outdoor Floor Lamp with Shade IP54</h3> <p>Weatherproof floor lamp - energy-saving - for garden, terrace, pool area with lampshade in the design of a living room floor lamp.</p>	<p>Weatherproof, for energy saving bulb E27 max. 23W Lamp to be ordered extra. max. dimensions of the lamp Ø 6cm / L 14 cm Voltage: 110V - 240V Material: Stainless steel / polycarbonate The floor lamp is equipped with a closed lampshade made of high-strength PC. To prevent overheating of the lampshade, do not use incandescent lamps. The lamp is only for energy saving bulbs. Includes 150 cm cable with plug Protection degree: IP54 Height: 149 cm Diameter: 40.5 cm Bottom plate (Ø / H): 31 / 5 cm LA-PF400</p>
	<h3>LED Garden Bollard Light Bipole 900</h3> 	<p>Rigid LED bollard and pathway lamp LA-PF410</p> <p>Max. Power 18 Watt Light distribution: dimmed with double-sided light emission downwards, another two pages for signal lights (both situations separately switchable) 18 watt LED (16W white 5000 Kelvin + 2W blue), electronic ballast</p> <p>Operating voltage: 220/230V 50/60Hz, material: Housing Die-cast aluminum Cover diffuser in transparent polycarbonate, Color: aluminum Impact resistance: IK10 Protection IP65, protection class I Dimensions: Height 950mm, Width 270mm, Depth 180mm Weight: 5,6 kg</p>
	<h3>LED Garden Bollard Light Tripole 900</h3> 	<p>Decorative, very stable and bright LED bollard light LA-PF412</p> <p>Max. Power 27 Watt Light distribution: with dimmed sided light emission downwards, other three sides for signal lights (both situations separately switchable) 27 watt LED (24W + 3W blue white 5000 Kelvin), electronic ballast</p> <p>Operating voltage: 220/230V 50/60Hz, material: Housing Die-cast aluminum Cover diffuser in transparent polycarbonate, Color: aluminum Impact resistance: IK10 Protection IP65, protection class I Dimensions: Height 950mm, Ø 250 Weight: 4,8 kg</p>

	<p>LED Stainless Steel Post Light Bali 1m</p>	<p>LED outdoor luminaire for indoor and outdoor use, e.g. garden or terrace. Remaining stock - only available in small quantities. LA-PF4530</p> <p>Decorative design with acrylic glass in bubble look. Illuminates evenly and with low glare. With power LED 1W Connected voltage: 230V Housing: stainless steel IP44 Diameter approx. 4.8 cm, height approx. 100cm This article can only be shipped as bulky goods - the surcharge is 17 Euro or by collection. Weight: kg</p>
	<p>Stainless Steel Postlight LED FLAME</p>	<p>Decorative stainless steel floor lamp 110cm with 1W LED, e.g. for garden lighting. Discontinued model - only 1 left in stock - LA-PF666</p> <p>Energy-saving garden and path light. Inside equipped with flame-like luminous body. LED bulb 1W clear, bright white. The outdoor light is made of glass and stainless steel. Splash-proof IP44, protection class 1. Connection voltage 230V Height 1,10 m, diam. 11,5 cm This item can only be shipped as bulky goods - the surcharge is 17 Euro once or by collection.</p> <p>Discontinued model - only 1 left in stock. Weight: 1 kg</p>

Solar Garden Lights

	<p>Solar Post Light LED 50cm</p>	<p>Post lamp 53cm for sunny countries. With LED and lenses for direct, bright light on the path. LA-PFS01</p> <p>High-quality, weatherproof post luminaire for surface mounting. Elegant aluminium housing. Suitable for garden, driveway, car park, access path, entrance. With bright LED 1.5 Watt. The brightness is stronger than the usual solar path lights. The energy is stored in a maintenance-free battery 3.7V 2.2Ah. Automatic switch-on via a light sensor in darkness. Charging time: 6 hours (in sunlight) Light duration: Up to 8 hours per night when fully charged. In bad weather, the light automatically dims down to significantly extend the lighting time even when the battery is low. Solar panel: 1.5W Material: Aluminium Colour: dark grey Lens: PC Ambient temperature: -20°C - +40°C Protection class: IP44 Recommended distance, luminaire to luminaire 4m.</p> <p>Dimensions: Height 530 mm Top 85 x 85mm Base 75 x 75mm Weight: 2 kg</p>
---	---	---

	<p>Rigid Solar Post Light Bright LED</p> 	<p>Stable stand light 80cm, solar bollard light with very bright LED. Also for public parks. Minimum order quantity: 12 pieces LA-PFS09</p> <p>High-quality, weatherproof post luminaire for surface mounting. Due to the solid aluminium housing, the luminaire cannot be easily kicked over. Therefore, this solar light is also suitable for public areas, access paths, facilities, etc. With very bright Power LED 2.3 Watt. The brightness is much stronger than with the usual solar path lights. Due to the large 4W solar panel, even in poor lighting conditions, e.g. in autumn or when it rains enough electricity to light up in the dark. The energy is stored in a maintenance-free AGM battery 6V 4.5Ah. Automatic switch-on via a light sensor in the dark. Charging time in sunlight: 6 hours Light duration: 8 hours per night when fully charged. Solar panel: 4W Material: Aluminium Colour: Black (from 20 pieces also available in natural polished steel) Diffuser: Polycarbonate Ambient temperature: -40°C - +60°C. Protection class IP65 Recommended distance: 4 - 6m (luminaire to luminaire) Dimensions: Height 800 mm Top part Ø 280 mm Weight: 4 kg</p>
	<p>Solar Light Post LED Aluminium 60cm with Sensor</p> 	<p>Post light 3W with solar panel and IR sensor. With bright LED light Minimum order quantity: 2 pieces LA-PFS18-1</p> <p>High-quality, weather-resistant post luminaire for surface mounting. Suitable for garden, driveway, parking, access path, entrance. With IR motion sensor wide range 120 °. This ensures a particularly long service life, even on dull autumn days. The brightness is much stronger than with the usual solar path lights. Due to the large solar panel, even in poor light conditions, e.g. In winter or during rain, sufficient electricity is generated to light up in the dark. Operating for 2 consecutive cloudy days. The energy is stored in a maintenance-free Li-Ion battery 7.4V 1.5 ah. Automatic switch on in the dark via the light sensor. The light gives dipped light all night for orientation. If the motion detector captures a person, the light is switched to full power for a short time.</p> <p>With bright power LEDs 3 watts Light color: 3000K warm white Luminous flux: 250 Lm Charging time in sunlight 6 hours Autarkic time: 8-12 hours when fully charged Solar Panel: 3W Motion sensor detection range: 5 - 8m Material: Aluminium Color: Black Diffuser: PC Ambient temperature: -20 C deg to + 45 C deg protection IP54 Recommended distance: 4 - 5m light to light Dimensions: height 600 mm, top Ø 210 mm MOQ: 2 pieces Weight: 3,5 kg</p>
	<p>Solar Light Post LED Aluminium 100cm with Sensor</p>	<p>Post light 3W with solar panel and IR sensor. With bright LED. Minimum order quantity: 2 pieces LA-PFS18-2</p>



Rigid Solar Post Light Bright LED with Sensor 90cm



Very bright, stable stand light made of aluminium 90cm, solar bollard light with LED and radar motion sensor omnidirectional.

Also for public parks.
LA-PFS29

High-quality, weatherproof post light for surface mounting.
This solar light is also suitable for public areas, access paths, facilities, etc.
With radar motion sensor. People are detected from all directions.
This ensures a particularly long operating time, even on dull winter days.

With very bright power LED.
The brightness is much higher than that of the usual solar path lights.
Due to the large 6W solar panel, enough power is generated even in poor lighting conditions, e.g. in winter or when it rains.
enough electricity to light up in the dark.
The energy is stored in a long-life lithium-iron battery (approx. 8-10 years).
Automatic switch-on via a light sensor in the dark.
The luminaire emits dimmed light 30% all night for orientation (also 0% basic lighting on request).
If the motion sensor detects a person, the light switches to full power for a short time.

- Light intensity: 220 Lm
- Light colour: 3000K warm white, 4000K natural white, 6000K bright white switchable.
- Charging time: 6 hours in sunlight
- Light duration: 10-12 hours per night when fully charged.
- Self-sufficient operating time 25 - 76h (2 - 6 nights in very cloudy weather)
- Solar panel: 6W
- Motion detector: Microwaves, detection range: 5m radius.
- Material: die-cast aluminium
- Colour: Black (can also be ordered in other colours at extra charge)
- Diffuser: Polycarbonate
- Ambient temperature: -40C to +60C.
- Protection class: IP65
- Recommended distance: 4 - 6m (luminaire to luminaire).

- Dimensions:
- Height 900 mm
- Top part Ø 275 mm
- Weight: 4 kg



Rigid Solar Post Light Bright LED Aluminium 7W

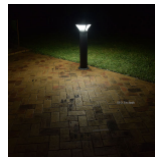

Solar powered aluminium bollard with very bright 3W power led. Massive aluminium die-cast. On surcharge with radar motion detector. LA-PFS33

High-quality, weather-resistant post-light for mount onto stone or concrete. Light source are white power LED with extreme long life time. The brightness is much more intensive that the common available solar pathway lights.

Automatic lamp start via the dawn light sensor. The luminaire gives dimmed light during the whole night. If the movement sensor detects a person, then the light turns to full power for a short time. With radar motion sensor. People are recognized from all directions. This ensures long service life, even on dull winter days. This bollard is much more brighter that the common available solar pathway lights.

Due to the large solar panel 7W, even in poor light conditions, e.g. In winter or during rain, sufficient electricity is generated to light up in the dark.

With bright power LEDs	3 watts
Light color:	3000K warm white
Luminous flux:	300 Lm
Charging time in sunlight	6 hours
Autarkic time:	8-12 hours when fully charged
Solar Panel:	7W
Motion sensor detection range:	5m
Battery:	Lithium Iron longlife 8-10 years
Material:	Aluminium die-cast
Color:	black (at 20 pcs. order production in natural polished)
Diffuser:	PC
Ambient temperature:	-30 C deg to + 60 C deg
Protection class	IP65
Recommended distance:	4 - 6m light to light
Dimensions:	height 1000 mm, top Ø 295 mm, ground plate Ø 180 mm
MOQ:	5 pieces

Weight: 4 kg



Solar Garden Post Light 100cm with double colour LED





A fantastic looking floor lamp with green / white LED lighting and sound control. LA-PFS50

Operated only by the solar panel and the integrated longlife battery. Automatic switch-on in the dark, with dimmed green light 25%. When noise is detected, bright white light is switched on for approx. 30 seconds.



High-quality aluminium construction.

Height	630 mm
Light Source:	LED
Battery voltage:	3.7v
Luminous Flux:	400 lm
CRI (Ra>):	80
Beam Angle(°):	360
Working Temperature:	-25 -+ 60C deg
Lifetime:	50000 hours
IP Rating:	IP65
Certification:	CE, FCC, RoHS
Weight:	2 kg

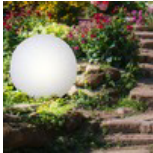

Garden, Post and Bollard Lights





	<p>Garden Light Cube DETT 30 x 30cm</p>	<p>LG-3010</p>
		<p>Robust luminaire, but not suitable for sitting down. This luminaire is simply placed on the ground or in the grass and gives a soft, glare-free light. Suitable for energy saving lamp E27 max. 24W No incandescent lamps should be used to avoid overheating. With power cable 2m Material polycarbonate. Protection class IP54 Dimensions: L 300mm, B 300mm, H 320mm Weight: 2,54 kg</p>
		<p>LG-3011 Weight: 1,3 kg</p>
	<p>Garden Light Ball 40cm Granite</p>	<p>Round Outdoor Light Globe with granite design. 230V powered LG-3012</p>
		<p>Robust light, but not suitable to sit. This garden lamp is simply placed on the ground or the grass and emits a soft, glare-free light. Suitable for energy-saving bulb E27 or LED max. 23W Do not use incandescent bulbs in order to avoid overheating. With power cord 3m Material polycarbonate. IP44 Dimensions: 400mm Weight: 1,3 kg</p>

Narrow Beam Spotlights Outdoor

	<p>Power LED Spot Light 5W with Ground Spike</p>	<p>Very bright LED ground spike spotlight to illuminate garden, plants, bushes LG-4505</p>
		<p>Round, bright light cone for illuminating large bushes or smaller trees. Light distribution 60 450 lumen Light colour: 3000K warm white (from 4 pieces can be ordered in 6000K cool white) Incl. short connection cable Power COB LED (clear white) Power 4-5 W Connection voltage 230 V Spike length 16,5 cm, Length of luminaire 18 cm. Housing made of aluminium IP 65 Weight: kg</p>

Garden, Post and Bollard Lights

	<p>Adjustable Garden Spot Light Halogen with ground spike</p>	<p>Filigrane massive aluminium halogenspot 20W-50W GU10 for outdoor. IP68 waterstream-proof. LG-4507</p>
		<p>Swivel halogen light. With anti blind visor for concentrated light beam. For garden or water features. For GU10 halogen lamps with max. 50 watt in spot, flood or colored. Halogen lamp has to be ordered extra. Operating voltage: 230V With connection cable 1.5 m and schuko plug IP68, water resistant, submersible for a short time. Housing: die-cast aluminum. Dimensions: Ø 94mm, H 100mm Weight: 0,5 kg</p>

	<p>Adjustable LED Garden Spot Light with ground spike</p>	<p>Small, swivelling aluminium LED spotlight for outdoor use. IP68 jet waterproof. White or coloured light. Only 1 piece left in stock ! LG-4508</p> <p>Swivel LED spot light with anti blind visor for concentrated light beam. Energy economizing and very long lamp life and improved light output. For garden or water features. Including LED lamps with white, blue or orange light. Operating voltage: 230V Power consumption: Max. 3 watt With connection cable 1.5 m and schuko plug IP68, water resistant, submersible for a short time. Housing: die-cast aluminium. Dimensions: Ø 94mm, H 100mm Weight: 0,5 kg</p>
	<p>Garden Spot Light LED Aluminium 3W</p>	<p>Small halogen floodlight with Power LED 3W in solid aluminium housing. IP68 jet waterproof Small stock: 1x grey, 1x black LG-4512</p> <p>Swivel spotlight with LED technology. For garden, facade or water features. Therefore very long lamp life and very low power consumption. Complete with replaceable LED lamp GU10. Connection voltage 230V With connecting cable 1,4m. Protection class IP68, water-resistant, submersible for short periods. Housing die-cast aluminium.</p> <p>Dimensions: Ø 95mm, H 110mm Weight: 0,5 kg</p>
	<p>Garden Spot Light Halogen Elbe 12V</p>	<p>Petite solid aluminium halogen spot MR16 20W for outdoor use. IP67 jet waterproof Only small remaining stock. LG-4515</p> <p>Swivelling halogen spotlight in low-voltage technology. Longer lamp life and better light distribution. For garden or water features. Can be fitted with MR16 halogen lamps 12V 20 Watt in spot, flood or coloured. Please order lamps and halogen transformer separately. Connecting voltage: 12V With connecting cable 1,5m. Protection class IP67, waterproof, immersible for short periods. Housing die-cast aluminium silver-grey.</p> <p>Dimensions: Ø 94mm, H 100mm Weight: 0,5 kg</p>
	<p>Garden Spot Light Halogen 50W GU10</p>	<p>Small halogen spotlight made of aluminium for halogen lamp GU10. IP66 for outdoor use Small stock: 1x grey, 1x black LG-4518</p> <p>Swivel spotlight for garden, facade or water features. With the enclosed ground spike, this spotlight can also be used for plant lighting. Please order the matching halogen lamp GU10 max. 50W separately. Connection voltage 230V With connecting cable 1,4m. Protection class IP66, jet water protected.</p> <p>Dimensions: Ø 95mm, H 110mm Weight: 0,5 kg</p>



Garden Spotlight Stainless Steel Fountain Water Feature Lighting



Solid stainless steel outdoor spotlight for PAR38 pressed glass lamp up to 80W. IP65 splash-proof.
Also for fountains and water features.
Discontinued item - small remaining stock
LG-4525

Supply voltage 230V
E27 for PAR38 max. 80W.
Lamp to be ordered separately.
Tilt 210 °
Wall, ceiling or floor mounting.
With 1.5 m cable
Dimensions:
Height 25cm,
Head D 15.5 cm.
Weight: 1,3 kg

Accessories for outdoor fixtures



Earth Spike for Garden Light
LG-4599

Fountain lighting and water feature lighting



Underwater LED Floodlight Stainless 6W



Stainless steel LED light fixture waterproof IP68, with the brightness of 60 watt halogen light.
Operation underwater, fountains, water bassins.
LG-4601

Intensive light distribution 15°
With 3 high performance LEDs.
This fixture may only be operated under water, to maintain a good surface cooling.
In 3.5m distance: Light circle diameter aprx. 100cm.
Light color: 3000K warm white (optionally 6000K cool white).
The brightness is comparable to a 60W halogen lamp.
Safe low-voltage operation 24V DC.
Power consumption 6 watts
24 Volt power supply must be ordered extra.
Not dimmable
With 10m connection cable
Protection class IP68
Casing: Stainless steel with swivel mounting bracket.
Width 115, height 115, depth 35 mm
Weight: 1,3 kg



Underwater LED Spotlight IP68 12W



Round stainless steel LED luminary waterproof 12 watt, with the brightness of 80 watt halogen light.
Operation underwater, fountains, water bassins.
LG-4630

Intensive light beam 30°
With high performance LEDs.
This fixture may only be operated under water, to maintain a good surface cooling.
In 3.5m distance: Light circle diameter aprx. 100cm.
Light color: 3000K warm white
Lumens: 770 Lm
The brightness is comparable to a 80W halogen lamp.
Safe low-voltage operation 24V DC.
Power consumption: 12 watts
24 Volt power supply ac or dc must be ordered extra.
Not dimmable
With 10m connection cable and weipu connector
Protection class IP68
Casing: Stainless steel
Diameter: 115mm
Height: 33 mm
Weight: 2 kg

Solar Garden Lights



**LED Solar Garden Light
Stainless with Spike**

LED inox garden light with solar cell.
LG-SOL02

The light source is a white LED with extremely long service life.
Autarkic time: 7 hours

The energy is stored in a NiMh battery and a light sensor automatically turns on in the dark.

Includes battery and LED bulbs.

Stainless steel, height 43 cm

Weight: 0,55 kg